

PROJECT INFORMATION		
JOB NAME		TYPE
ORDERING CODE		

## NU essentials

### 4" Round & Square Wall Wash Standard White



WW BEAM		
(Note: Specifications are subject to change without notice)		
14mm COB PERFORMANCE DATA		
LED LIGHT ENGINE	NOMINAL DELIVERED LUMENS	SYSTEM WATTAGE
07LM	620LM @30K/90CRI	10.5W
10LM	890LM @30K/90CRI	15.5W
13LM	1150LM @30K/90CRI	20.5W
Notes	Delivered lumens based on WW optic (see page 2)	



eldoLED  
your product | our drive



#### FEATURES

- Economical choice for budget projects
- Thermally optimized for LED longevity
- Fully casted assembly
- Packaging material consists of 60-80% post-consumer recycled fiber

#### DIMMING AND CONTROLS

- eldoLED Flicker free 0-10V dimming to 1%
- Leading & trailing edge (Triac/ELV) dimming to 1%

#### CONSTRUCTION

- Aluminum trim and bezel
- Electrocoated 16-gauge cold-rolled steel construction
- Accommodates ceiling thickness from 1/4" to 1"

#### LED

- 90 CRI: SDCM = 2-step MacAdam Ellipse, Lumen Maintenance:  $L_{70} > 66,000$  hrs

#### LISTING

- ULus Listed to UL1598 & UL2108; cUL Listed to CSA C22.2 #250.0
- NSF/ANSI-2 with lens (Non-Food and Splash Zones)
- IP44 with lens - suitable for wet location with lens - suitable damp location without lens
- 5 Year Limited warranty

#### ELECTRICAL

- 120V-277V, 120 only Triac / ELV
- Power factory  $\geq 0.9$
- 2kV driver input surge protection
- 7W and 10W (T20 CEC) EM 90min battery
- Max. ambient installation temperature 104°F (40°C)

#### FIXTURE HEIGHT

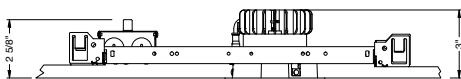

#### ROUND

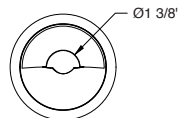

ceiling cutout  
4" diameter  
ceiling thickness  
1/4" to 1"

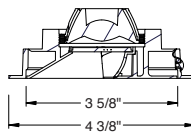

aperture dimensions

#### SQUARE

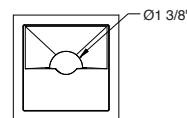

ceiling cutout  
4" x 4" square  
ceiling thickness  
1/4" to 1"

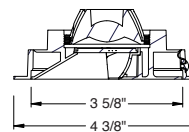

aperture dimensions

# alphabet

PROJECT INFORMATION		
JOB NAME		TYPE
ORDERING CODE		

WW BEAM ORDERING CODE	
<b>SERIES</b>	NUE4 NUE
<b>TYPE</b>	RW round wall wash QW square wall wash
<b>LED</b>	SW standard white
<b>DELIVERED LUMENS</b>	07LM 620 lm 10LM 890 lm 13LM 1150 lm Standard Configuration: 3000K 90CRI WW
<b>CCT</b>	27K 2700K 30K 3000K 35K 3500K 40K 4000K
<b>CRI</b>	90 90 CRI
<b>OPTIC &amp; LM MULTIPLIER</b> SEE PAGE 3	WW wall wash
<b>TRIM COLOR</b>	BK black WH white MC matte chrome
<b>BEZEL COLOR</b>	BK black (0.95) WH white (1.00) MC matte chrome (0.99)

WW BEAM ORDERING CODE	
<b>MOUNTING OPTIONS</b> SEE PAGE 4, 5	NC new construction with ceiling fitting plate NCIC <sup>1</sup> new construction with ceiling fitting plate, insulation contact rated (no housing required) IC <sup>2</sup> insulation contact housing ICAT <sup>2</sup> insulation contact/airtight housing CP chicago plenum housing RET retrofit, no ceiling fitting plate RETIC <sup>1</sup> retrofit, no ceiling fitting plate, insulation contact rated (no housing required)
<b>VOLTAGE</b>	120 120V UNV 120V-277V
<b>DIMMING</b>	DIM10 eldoLED flicker free 0-10V dimming to 1% ELV1 <sup>3</sup> leading & trailing edge (Triac/ELV) dimming to 1%
<b>ELECTRICAL OPTIONS</b>	EM7 emergency battery backup, 90 minutes at 7W to LED EM10CA20 emergency battery backup, 90 minutes at 10W to LED, CA title 20

ADDITIONAL MOUNTING INFO	
New Construction Bar Hangers (included)	Mounting Length: 14-3/4" to 26"
Extension Kit p/n: K20266 (ordered separately, 1 per fixture)	Extends a pair of Bar Hangers Total Mounting Length: 29" to 48"

YOUR COMPLETED ORDERING CODE
Follow the steps to specify your fixture, example: <b>NUE4 - RW - SW - 10LM - 30K - 90 - WW- WH - WH - NC - UNV - DIM10</b>

## NOTES

1. NCIC & RETIC available in 07LM, rated for insulation contact (IC), no "IC-housing" required.
2. IC or ICAT housing are JA8 compliant.
3. ELV1 available in 120V.

## TRIM OPTIONS

### TRIM/BEZEL COLORS



PROJECT INFORMATION		
JOB NAME		TYPE
ORDERING CODE		

## PHOTOMETRIC DATA CHARTS

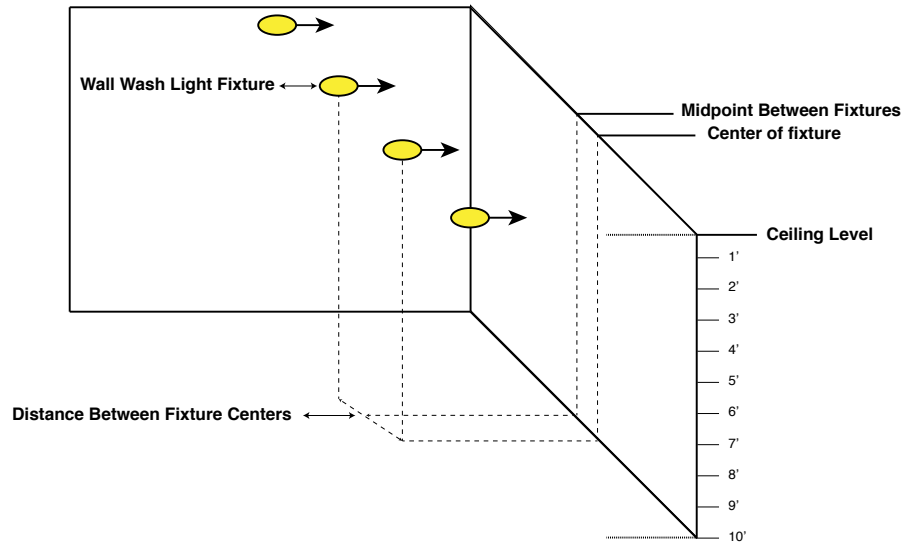

### FOOT CANDLE MEASUREMENT

Static White Wall Wash 13LM, 90CRI, 3000K												
MOUNTING DISTANCE	2' FROM WALL				3' FROM WALL				4' FROM WALL			
FIXTURE SPACING	2' ON CENTER		3' ON CENTER		3' ON CENTER		4' ON CENTER		4' ON CENTER		5' ON CENTER	
DISTANCE FROM CEILING	CENTER	MID POINT	CENTER	MID POINT	CENTER	MID POINT	CENTER	MID POINT	CENTER	MID POINT	CENTER	MID POINT
1'	44.1	42.3	34.1	24.4	15.3	14.3	12.8	9.6	6.7	6.2	5.8	4.5
2'	41.1	40.2	30.6	25.5	20.4	20.2	16.3	14.6	11	10.6	9.4	8
3'	34.5	33.9	26.2	22	18.3	17.9	14.8	13.1	11.3	11.1	9.4	8.8
4'	29.7	29.5	22.3	19.6	16.1	15.8	13.1	11.7	10.3	10.1	8.7	7.9
5'	24.6	24.8	18.2	17	14.6	14.4	11.9	10.8	9.3	9.1	7.9	7.3
6'	19.7	19.9	14.4	14.1	13.2	13.1	10.7	10	8.6	8.5	7.3	6.8
7'	15.5	15.7	11.5	11.4	11.7	11.7	9.4	9	8	7.9	6.8	6.4
8'	12.2	12.4	9.2	9.2	10.2	10.3	8.2	8	7.4	7.4	6.3	6
9'	9.6	9.8	7.4	7.5	8.7	8.8	7	7	6.8	6.8	5.7	5.6
10'	7.7	7.8	6	6.1	7.5	7.6	6	6	6.1	6.2	5.2	5.1
11'	6.2	6.3	4.9	5	6.3	6.5	5.2	5.2	5.5	5.6	4.7	4.6
12'	5.1	5.2	4.1	4.2	5.4	5.5	4.5	4.5	4.9	5	4.2	4.2

Static White Wall Wash 10LM, 90CRI, 3000K												
MOUNTING DISTANCE	2' FROM WALL				3' FROM WALL				4' FROM WALL			
FIXTURE SPACING	2' ON CENTER		3' ON CENTER		3' ON CENTER		4' ON CENTER		4' ON CENTER		5' ON CENTER	
DISTANCE FROM CEILING	CENTER	MID POINT	CENTER	MID POINT	CENTER	MID POINT	CENTER	MID POINT	CENTER	MID POINT	CENTER	MID POINT
1'	34.3	32.9	26.4	18.9	11.9	11.1	9.9	7.4	5.2	4.8	4.5	3.5
2'	31.9	31.2	23.8	19.8	15.8	15.7	12.6	11.3	8.6	8.2	7.3	6.2
3'	26.7	26.3	20.3	17.1	14.2	13.9	11.5	10.2	8.8	8.6	7.3	6.8
4'	23	22.9	17.3	15.2	12.5	12.3	10.2	9.1	8	7.8	6.7	6.2
5'	19.1	19.2	14.1	13.2	11.3	11.2	9.2	8.4	7.2	7.1	6.1	5.7
6'	15.3	15.4	11.2	11	10.2	10.2	8.3	7.7	6.7	6.6	5.7	5.3
7'	12	12.2	8.9	8.9	9.1	9.1	7.3	7	6.2	6.2	5.3	5
8'	9.4	9.6	7.1	7.2	7.9	8	6.3	6.2	5.8	5.7	4.9	4.7
9'	7.5	7.6	5.7	5.8	6.8	6.9	5.5	5.4	5.3	5.3	4.5	4.3
10'	6	6.1	4.7	4.7	5.8	5.9	4.7	4.7	4.8	4.8	4	4
11'	4.8	4.9	3.8	3.9	4.9	5	4	4.1	4.3	4.3	3.6	3.6
12'	3.9	4	3.2	3.3	4.2	4.3	3.5	3.5	3.8	3.9	3.2	3.2

**NOTE**

1. Performance based on typical reflectance values and room dimensions. IES files available at ledrabrands.com

PROJECT INFORMATION		
JOB NAME	TYPE	
ORDERING CODE		

## PHOTOMETRIC DATA CHARTS (CONTINUED)

### Static White Wall Wash 07LM, 90CRI, 3000K

MOUNTING DISTANCE	2' FROM WALL				3' FROM WALL				4' FROM WALL			
	2' ON CENTER		3' ON CENTER		3' ON CENTER		4' ON CENTER		4' ON CENTER		5' ON CENTER	
FIXTURE SPACING	2' ON CENTER		3' ON CENTER		3' ON CENTER		4' ON CENTER		4' ON CENTER		5' ON CENTER	
DISTANCE FROM CEILING	CENTER	MID POINT	CENTER	MID POINT	CENTER	MID POINT	CENTER	MID POINT	CENTER	MID POINT	CENTER	MID POINT
1'	23.9	22.9	18.4	13.2	8.3	7.7	6.9	5.2	3.6	3.3	3.1	2.4
2'	22.2	21.8	16.5	13.8	11	10.9	8.8	7.9	6	5.7	5.1	4.3
3'	18.6	18.3	14.2	11.9	9.9	9.7	8	7.1	6.1	6	5.1	4.7
4'	16	16	12	10.6	8.7	8.6	7.1	6.4	5.5	5.4	4.7	4.3
5'	13.3	13.4	9.8	9.2	7.9	7.8	6.4	5.9	5	4.9	4.3	3.9
6'	10.6	10.8	7.8	7.6	7.1	7.1	5.8	5.4	4.7	4.6	4	3.7
7'	8.4	8.5	6.2	6.2	6.3	6.3	5.1	4.9	4.3	4.3	3.7	3.5
8'	6.6	6.7	5	5	5.5	5.6	4.4	4.3	4	4	3.4	3.2
9'	5.2	5.3	4	4	4.7	4.8	3.8	3.8	3.7	3.7	3.1	3
10'	4.1	4.2	3.2	3.3	4	4.1	3.3	3.3	3.3	3.3	2.8	2.8
11'	3.3	3.4	2.7	2.7	3.4	3.5	2.8	2.8	3	3	2.5	2.5
12'	2.7	2.8	2.2	2.3	2.9	3	2.4	2.4	2.7	2.7	2.2	2.2

NOTE  
1. Performance based on typical reflectance values and room dimensions. IES files available at [ledrbrands.com](http://ledrbrands.com)

## MOUNTING OPTIONS

### FIXTURE HEIGHT

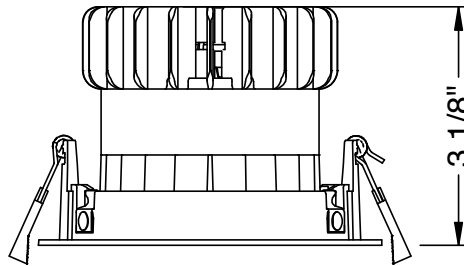

## NC - NEW CONSTRUCTION

### TRIM

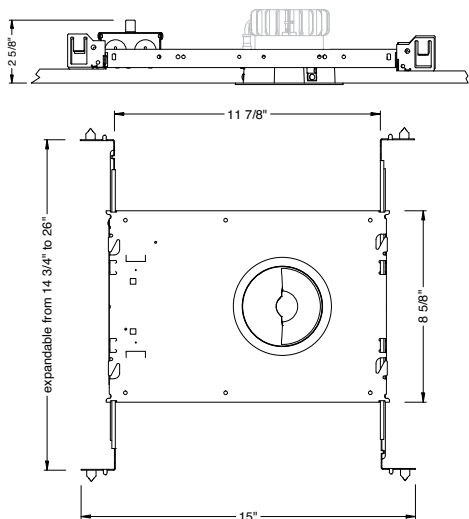

### ROUND

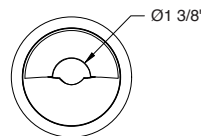

ceiling cutout  
4" diameter  
ceiling thickness  
1/4" to 1"

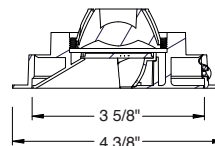

aperture dimensions

### SQUARE

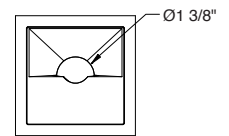

ceiling cutout  
4" x 4" square  
ceiling thickness  
1/4" to 1"

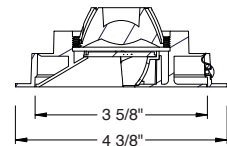

aperture dimensions

PROJECT INFORMATION		
JOB NAME	TYPE	
ORDERING CODE		

## MOUNTING OPTIONS (CONTINUED)

### NC - RET - NCIC - RETIC

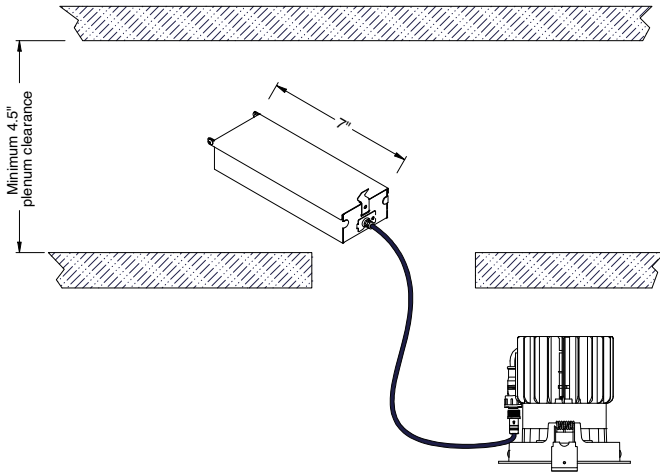

### IC - INSULATION CONTACT HOUSING ICAT - INSULATION CONTACT / AIR TIGHT CP - CHICAGO PLENUM

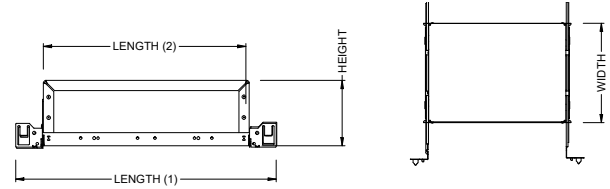

BOX SIZE	L 1	L 2	W	H
A	15 - 7/16"	11 - 3/4"	8 - 1/2"	6 - 3/4"

RATINGS / CERTIFICATIONS	NC	RET	IC	ICAT	CP	NCIC	RETIC
TYPE NON-IC	✓	✓					
TYPE IC			✓	✓		✓	✓
CHICAGO PLENUM (CCEA)					✓		
SUITABLE FOR AIR HANDLING PLENUMS	✓	✓	✓	✓	✓	✓	✓

BOX TYPE / LUMEN OUTPUT - STANDARD BEAMS (WW)			
LUMEN OUTPUT	BOX - A		
	IC	ICAT	CP
07LM	✓	✓	✓
10LM	✓	✓	✓
13LM	✓	✓	✓

CEILING THICKNESS	
FIXTURE TYPE	MOUNTING TYPE
	STANDARD CEILING THICKNESS
TRIM	1/4" to 1"

PROJECT INFORMATION		
JOB NAME		TYPE
ORDERING CODE		

## BATTERY OPTIONS

### EMERGENCY BATTERY

IOTA's ILB Battery Backups are UL Listed LED emergency drivers that allow the same LED fixture to be used for both normal and emergency operation. In the event of a power failure, the ILB switches to the emergency mode and operates the existing fixture for 90 minutes. The unit contains a battery, charger, and converter circuit in a single can. The Constant Power design of the ILB maintains the output wattage to the LED array even as the system voltage diminishes. UL 924 Listed for U.S. and Canada. UL 1310 Certified, Output Class 2 Compliant. Includes single-piece TBTS test switch and charge indicator accessory kit. For use with switched and unswitched fixtures, and includes Two-wire universal AC input. Meets or exceeds all National Electric Code and Life Safety Code Emergency Lighting Requirements. Rated for use in Plenum, Damp Location, Recessed Type IC, and Enclosed and Gasketed Luminares.

### REMOTE TEST SWITCH

The Remote Test Switch may be mounted adjacent to the LED Fixture by others.

### EMERGENCY BATTERY ACCESS

Above ceiling access is required.

### REMOTE LOCATION

Maximum remote mounting distance of the emergency driver shall be 50 feet. Remote location wiring provided by others. Follow all Local and National Electric/ Building Codes.

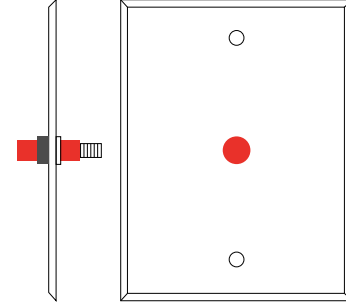

Remote Test Switch

EM MODE OUTPUT (DELIVERED LUMENS)		
LUMEN ORDERING CODE	EM7	EM10
ALL OPTIONS (07LM TO 13LM)	690LM	990LM
Notes: Based on 30K, 90CRI		

### NC - NEW CONSTRUCTION WITH EM BATTERY (REMOTE TEST SWITCH)

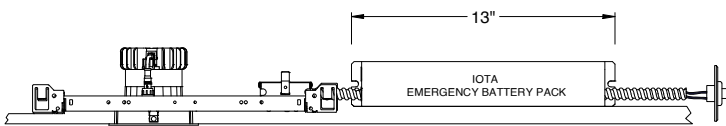

### IC / ICAT / CP - INSULATION CONTACT HOUSING WITH EM BATTERY (REMOTE TEST SWITCH)

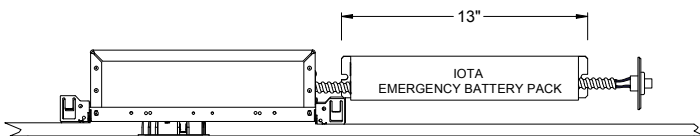

### RET - RETROFIT WITH EM BATTERY (REMOTE TEST SWITCH)

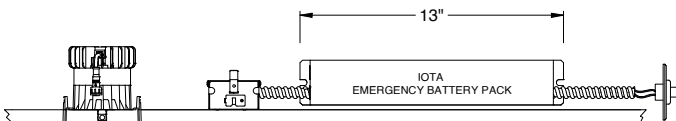

### Accessory

76066 Optional T-Grid Mounting Kit<sup>1</sup>

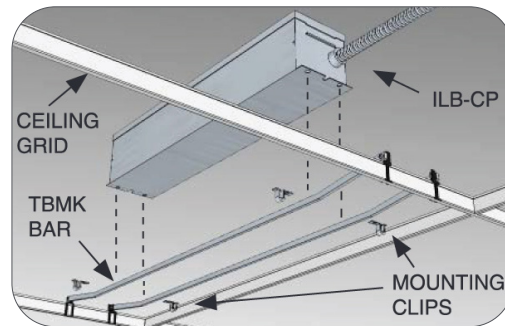

1. Can be used with any of the Emergency Battery Backups. Must be ordered as a separate line item.