

PROJECT INFORMATION		
JOB NAME		TYPE
ORDERING CODE		

## NU4

### 4" Square Wall Wash Tunable White



WW BEAM (Note: Specifications are subject to change without notice)		
14mm COB PERFORMANCE DATA LUMINUS		
LED LIGHT ENGINE	NOMINAL DELIVERED LUMENS	SYSTEM WATTAGE
10LM	1050LM @35K/95CRI	15W
15LM	1350LM @35K/95CRI	19W
20LM	1800LM @35K/95CRI	25W
Notes	Delivered lumens based on WW optic with no lens, (see page 2)	

WW BEAM (Note: Specifications are subject to change without notice)		
14mm COB PERFORMANCE DATA NICHIA		
LED LIGHT ENGINE	NOMINAL DELIVERED LUMENS	SYSTEM WATTAGE
10LM	1020M @35K/80CRI	12W
15LM	1500LM @35K/80CRI	18W
20LM	1810M @35K/80CRI	22W
25LM	2250LM @35K/80CRI	28W
Notes	Delivered lumens based on WW optic with no lens, (see page 2)	

LUMINUS See Page 2 | NICHIA See Page 3 | eldoLED your protected luminaire

CASAMBI | nLIGHT

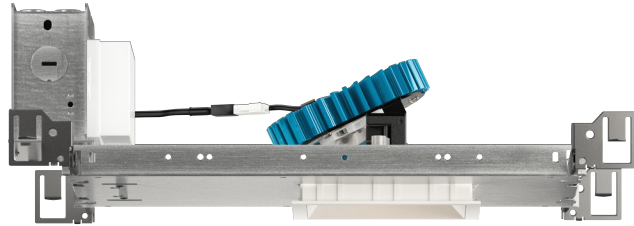

Trim

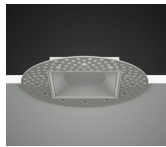

Trimless



Trimless Millwork

#### FEATURES

- An asymmetric reflector with highly efficient BrightView angle bending lens produces excellent wall washing with no scalloping
- 4" set back with 6' on center spacing - 15 FC average
- 3/4" bezel regress with 1/16" micro flange
- UGR <18
- Custom finishes available
- Microban® antimicrobial finish available on all exposed painted surfaces

#### DIMMING AND CONTROLS

- eldoLED flicker free 0-10V dimming to 0% and 1%
- eldoLED flicker free DALI dimming to 0% and 1%
- Leading & trailing edge (Triac/ELV) dimming to 1%
- Casambi bluetooth dimming to 0%
- nLight control interface dimming to 0%

#### CONSTRUCTION

- Lexan™ (PC) highly resistant to impact and heat (240°F)
- Optimal material for wireless BLE signal connectivity
- Shatter proof acrylic bezel lens
- Electrocoated 16-gauge cold-rolled steel construction
- Accommodates ceiling thickness from 1/8" to 1-1/4"

#### LED

- Luminus tunable white COB: 95 CRI, R9 > 70; SDCM = 4-step MacAdam Ellipse; Lumen Maintenance: L<sub>70</sub> > 54,000 hrs
- Nichia tunable white COB: 80 CRI, R9 > 0; SDCM = 3-step MacAdam Ellipse; Lumen Maintenance: L<sub>80</sub> > 33,000 hrs

#### LISTING

- ULus Listed to UL1598 & UL2108; cUL Listed to CSA C22.2 #250.0
- IP65 with lens - Suitable for wet locations with lens - Suitable for damp locations without lens
- Non-conductive, dead-front construction (shower approved)
- NSF/ANSI-2 with lens (Non-Food and Splash Zones)
- 5 Year Limited warranty

#### ELECTRICAL

- 120V-277V, 120 only Triac / ELV
- Power factor ≥ 0.9
- 2kV driver input surge protection
- Max. ambient installation temperature 95°F (35°C)

#### FIXTURE HEIGHT

10LM - 20LM LOW LUMENS

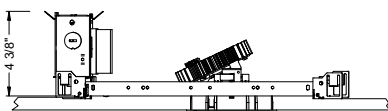

25LM HIGH LUMENS

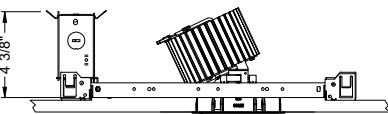

#### TRIMMED

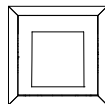

ceiling cutout  
4-1/4" square  
ceiling thickness  
1/8" to 1-1/4"

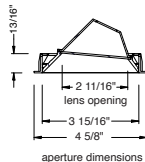

aperture dimensions

#### TRIMLESS

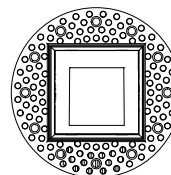

ceiling cutout  
4-1/2" square  
ceiling thickness  
3/8" to 1-1/4"

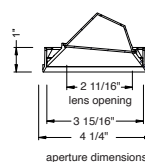

aperture dimensions

#### MILLWORK

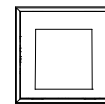

ceiling cutout  
4-1/4" square  
ceiling thickness  
5/8" to 1-1/4"

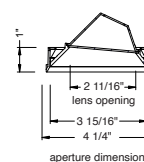

aperture dimensions

# alphabet

PROJECT INFORMATION		
JOB NAME		TYPE
ORDERING CODE		

WW BEAM ORDERING CODE																										
<b>SERIES</b>	<b>NU4</b>	NU4																								
<b>TYPE</b>	<b>QW</b>	square wall wash																								
	<b>QWT</b>	square wall wash trimless																								
	<b>QWTMW</b>	square wall wash trimless millwork																								
<b>LED</b>	<b>TW</b>	tunable white (Luminus)																								
<b>DELIVERED LUMENS</b>	<b>10LM</b>	1050 lm																								
	<b>15LM</b>	1350 lm																								
	<b>20LM</b>	1800 lm																								
Standard Configuration: 3500K 95CRI Calculated Delivered Lumens = [Delivered Lumen Value] x [CCT Multiplier]																										
<b>CCT</b>	<b>2765</b>	2700K to 6500K tunable white																								
		<table border="1"> <thead> <tr> <th>CCT</th> <th>2700K</th> <th>3000K</th> <th>3500K</th> <th>4000K</th> <th>5000K</th> <th>5700K</th> <th>6500K</th> </tr> </thead> <tbody> <tr> <td>CCT MULTIPLIER FOR LUMEN OUTPUT</td> <td>0.91</td> <td></td> <td>1.00</td> <td>0.99</td> <td>1.00</td> <td>1.01</td> <td>1.02</td> </tr> <tr> <td>EML RATIO</td> <td>0.49</td> <td>0.57</td> <td>0.68</td> <td>0.79</td> <td>0.96</td> <td>1.04</td> <td>1.12</td> </tr> </tbody> </table>	CCT	2700K	3000K	3500K	4000K	5000K	5700K	6500K	CCT MULTIPLIER FOR LUMEN OUTPUT	0.91		1.00	0.99	1.00	1.01	1.02	EML RATIO	0.49	0.57	0.68	0.79	0.96	1.04	1.12
		CCT	2700K	3000K	3500K	4000K	5000K	5700K	6500K																	
CCT MULTIPLIER FOR LUMEN OUTPUT	0.91		1.00	0.99	1.00	1.01	1.02																			
EML RATIO	0.49	0.57	0.68	0.79	0.96	1.04	1.12																			
<b>CCT</b>	<b>1840</b>	1800K to 4000K tunable white																								
		<table border="1"> <thead> <tr> <th>CCT</th> <th>1800K</th> <th>2000K</th> <th>2400K</th> <th>2700K</th> <th>3000K</th> <th>3500K</th> <th>4000K</th> </tr> </thead> <tbody> <tr> <td>CCT MULTIPLIER FOR LUMEN OUTPUT</td> <td>0.67</td> <td>0.74</td> <td>0.8</td> <td>0.85</td> <td>0.88</td> <td>0.95</td> <td>1.01</td> </tr> </tbody> </table>	CCT	1800K	2000K	2400K	2700K	3000K	3500K	4000K	CCT MULTIPLIER FOR LUMEN OUTPUT	0.67	0.74	0.8	0.85	0.88	0.95	1.01								
		CCT	1800K	2000K	2400K	2700K	3000K	3500K	4000K																	
CCT MULTIPLIER FOR LUMEN OUTPUT	0.67	0.74	0.8	0.85	0.88	0.95	1.01																			
<b>CRI</b>	<b>95</b>	95 typical, 90 minimum																								
<b>OPTIC &amp; LM MULTIPLIER</b> SEE PAGE 4	<b>WW</b>	wall wash with diffused angle bending lens																								
<b>TRIM COLOR</b> SEE PAGE 4	<b>BK</b>	black																								
	<b>WH</b>	white																								
	<b>MC</b>	matte chrome																								
	<b>BZ</b>	bronze																								
	<b>WT</b>	wheat																								
	<b>CC<sup>1</sup></b>	custom color, consult factory for details																								
Antimicrobial finish, add <b>AM</b> to black, white or matte chrome i.e. BKAM. Not applicable to trimless option. Do not include in trimless ordering code.																										
<b>BEZEL COLOR</b> SEE PAGE 4	<b>BK</b>	black (0.98)																								
	<b>WH</b>	white (1.00)																								
	<b>MC</b>	matte chrome (0.99)																								
	<b>BZ</b>	bronze (0.98)																								
	<b>WT</b>	wheat (0.99)																								
	<b>CC<sup>1</sup></b>	custom color, consult factory for details																								
Antimicrobial finish, add <b>AM</b> to black, white or matte chrome i.e. BKAM.																										

WW BEAM ORDERING CODE		
<b>MOUNTING OPTIONS</b> SEE PAGE 8, 9	<b>NC</b>	new construction with ceiling fitting plate
	<b>RET</b>	retrofit, no ceiling fitting plate
<b>VOLTAGE</b>	<b>120</b>	120V
	<b>UNV</b>	120V-277V
<b>DIMMING</b>	<b>DIM10Z<sup>2</sup></b>	eldoLED flicker free 0-10V dimming to 0%
	<b>DALIZ</b>	eldoLED flicker free DALI dimming to 0%
	<b>NLT</b>	nLight control interface: standard Cat-5/RJ45 connection (female), dimming to 0%
	<b>CASZ</b>	Casambi Bluetooth dim to zero

ADDITIONAL MOUNTING INFO	
New Construction Bar Hangers (included)	Mounting Length: 14-3/4" to 26"
Extension Kit p/n: K20266 (ordered separately, 1 per fixture)	Extends a pair of Bar Hangers Total Mounting Length: 29" to 48"

YOUR COMPLETED ORDERING CODE
Follow the steps to specify your fixture, example: <b>NU4 - QW - TW - 10LM - 2765 - 95 - WW - WH - WH - NC - UNV - DIM10Z</b>

## NOTES

1. Custom set up fee plus minimum quantity required per color.
2. Requires 2 wall controllers (see wiring diagram).

\* EML = equivalent melanopic lux. To calculate EML, multiply the measured photopic lux by the EML ratio for the given CCT.  
Example: 254 lux x 0.79 = 200 melanopic lux at 4000K.

\* EldoLED uses logarithmic dimming curve as standard. For linear dimming curve, add "LIN" after dimming code, i.e. DIM10LIN.

# alphabet

PROJECT INFORMATION		
JOB NAME		TYPE
ORDERING CODE		

## WW BEAM ORDERING CODE

SERIES	NU4	NU4
TYPE	QW	square wall wash
	QWT	square wall wash trimless
	QWTMW	square wall wash trimless millwork
LED	TW	tunable white (Nichia)
DELIVERED LUMENS	10LM	1020 lm
	15LM	1500 lm
	20LM	1810 lm
	25LM	2250 lm
Standard Configuration: 3500K 80CRI Calculated Delivered Lumens = [Delivered Lumen Value] x [CCT Multiplier]		
CCT	2750	2700K to 5000K tunable white
CRI	80	80 CRI
OPTIC & LM MULTIPLIER SEE PAGE 4	WW	wall wash with diffused angle bending lens
TRIM COLOR SEE PAGE 4	BK	black
	WH	white
	MC	matte chrome
	BZ	bronze
	WT	wheat
	CC <sup>1</sup>	custom color, consult factory for details
Antimicrobial finish, add <b>AM</b> to black, white or matte chrome i.e. BKAM.		
Not applicable to trimless option. Do not include in trimless ordering code.		
BEZEL COLOR SEE PAGE 4	BK	black (0.98)
	WH	white (1.00)
	MC	matte chrome (0.99)
	BZ	bronze (0.98)
	WT	wheat (0.99)
	CC <sup>1</sup>	custom color, consult factory for details
Antimicrobial finish, add <b>AM</b> to black, white or matte chrome i.e. BKAM.		

## WW BEAM ORDERING CODE

MOUNTING OPTIONS SEE PAGE 8, 9	NC	new construction with ceiling fitting plate
	RET	retrofit, no ceiling fitting plate
VOLTAGE	120	120V
	UNV	120V-277V
DIMMING	DIM10Z <sup>2</sup>	eldoLED flicker free 0-10V dimming to 0%
	DALIZ	eldoLED flicker free DALI dimming to 0%
	NLT	nLight control interface: standard Cat-5/RJ45 connection (female), dimming to 0%
	CASZ	Casambi Bluetooth dim to zero

## ADDITIONAL MOUNTING INFO

New Construction Bar Hangers (included)	Mounting Length: 14-3/4" to 26"
Extension Kit p/n: K20266 (ordered separately, 1 per fixture)	Extends a pair of Bar Hangers Total Mounting Length: 29" to 48"

## YOUR COMPLETED ORDERING CODE

Follow the steps to specify your fixture, example:
<b>NU4 - QW - TW - 10LM - 2750 - 80 - WW - WH - WH - NC - UNV - DIM10Z</b>

## NOTES

1. Custom set up fee plus minimum quantity required per color.
2. Requires 2 wall controllers (see wiring diagram).

\*EML = equivalent melanopic lux. To calculate EML, multiply the measured photopic lux by the EML ratio for the given CCT.  
Example: 254 lux x 0.79 = 200 melanopic lux at 4000K.

\*EldoLED uses logarithmic dimming curve as standard. For linear dimming curve, add "LIN" after dimming code, i.e. DIM10LIN.

# alphabet

PROJECT INFORMATION		
JOB NAME		TYPE
ORDERING CODE		

## TRIM OPTIONS

### TRIM/BEZEL COLORS



WH

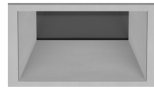

MC



BK



BZ

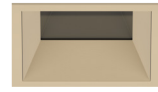

WT

## PHOTOMETRIC DATA DIAGRAM

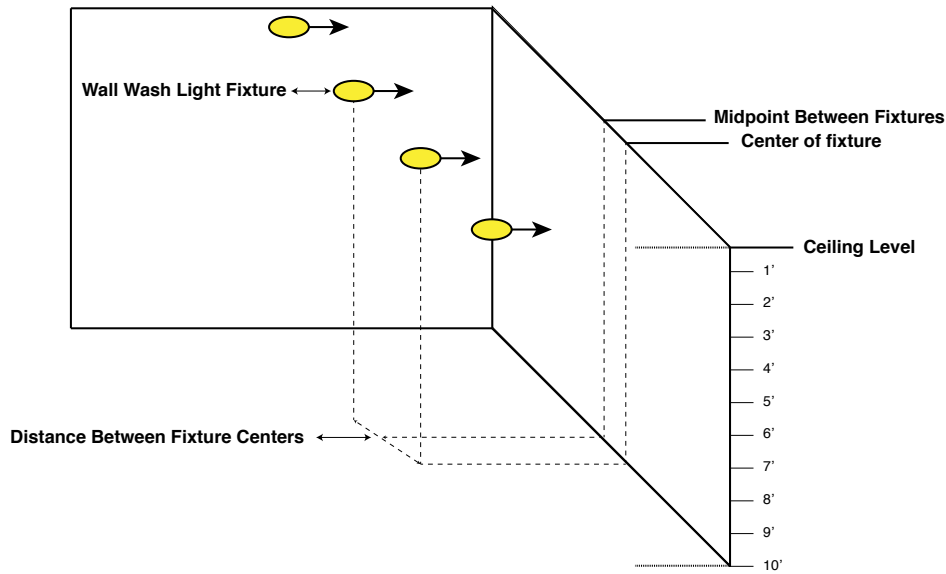

## PHOTOMETRIC DATA CHARTS - LUMINUS

### FOOT CANDLE MEASUREMENT

Tunable White (Luminus) Wall Wash 20LM, 95CRI, 3500K

MOUNTING DISTANCE	2' FROM WALL						3' FROM WALL						4' FROM WALL					
	2' ON CENTER		3' ON CENTER		4' ON CENTER		2' ON CENTER		3' ON CENTER		4' ON CENTER		3' ON CENTER		4' ON CENTER		6' ON CENTER	
FIXTURE SPACING																		
DISTANCE FROM CEILING	CENTER	MID POINT	CENTER	MID POINT	CENTER	MID POINT	CENTER	MID POINT	CENTER	MID POINT	CENTER	MID POINT	CENTER	MID POINT	CENTER	MID POINT	CENTER	MID POINT
1'	47.2	55	30.8	34.9	28	20.3	11	12.2	7.6	8.8	5.9	6.2	3.4	3.6	2.6	2.9	2	1.7
2'	105.8	110.6	70.9	73.9	58	51.5	52.9	59.4	37.3	40.8	26.9	30.3	15.6	17.7	11.8	13.7	7.7	8.7
3'	79.3	82.5	55.7	58.3	43.1	43.5	63.9	68.3	47	49.1	35.2	37.2	30.4	33.6	23.9	25.7	15.7	16.7
4'	51.8	53.7	38.4	40.1	29.8	31	51.9	54.7	39.9	41.6	30.8	32.2	33.1	35.3	26.4	27.6	17.7	18.5
5'	33.5	34.6	26.2	27.3	20.8	21.7	38.3	40	30.8	32	24.5	25.5	29.1	30.7	23.7	24.7	16.3	17
6'	22.1	22.8	18.1	18.8	14.8	15.4	27.7	28.7	23	23.9	18.8	19.6	23.8	25	19.8	20.6	13.9	14.6
7'	15.1	15.5	12.8	13.3	10.7	11.1	20	20.6	17.2	17.8	14.4	15	18.9	19.7	16.1	16.7	11.6	12.2
8'	10.7	10.9	9.3	9.6	8	8.3	14.7	15.1	12.9	13.3	11.1	11.5	14.9	15.4	12.9	13.4	9.6	10
9'	7.7	7.9	6.9	7.1	6	6.3	11	11.2	9.8	10.1	8.6	8.9	11.7	12.2	10.4	10.8	7.9	8.3
10'	5.8	5.9	5.2	5.4	4.7	4.8	8.3	8.5	7.6	7.8	6.8	7	9.3	9.6	8.4	8.6	6.5	6.8

**NOTE**

1. Performance based on typical reflectance values and room dimensions. IES files available at ledrabrands.com

PROJECT INFORMATION		
JOB NAME		TYPE
ORDERING CODE		

## PHOTOMETRIC DATA CHARTS - LUMINUS

### FOOT CANDLE MEASUREMENT

Tunable White (Luminus) Wall Wash 15LM, 95CRI, 3500K																		
MOUNTING DISTANCE	2' FROM WALL						3' FROM WALL						4' FROM WALL					
FIXTURE SPACING	2' ON CENTER		3' ON CENTER		4' ON CENTER		2' ON CENTER		3' ON CENTER		4' ON CENTER		3' ON CENTER		4' ON CENTER		6' ON CENTER	
DISTANCE FROM CEILING	CENTER	MID POINT	CENTER	MID POINT	CENTER	MID POINT	CENTER	MID POINT	CENTER	MID POINT	CENTER	MID POINT	CENTER	MID POINT	CENTER	MID POINT	CENTER	MID POINT
1'	35.6	41.4	23.2	26.3	21.1	15.3	8.3	9.2	5.7	6.6	4.4	4.7	2.6	2.7	1.9	2.2	1.5	1.3
2'	79.7	83.3	53.5	55.7	43.7	38.8	39.9	44.8	28.1	30.8	20.2	22.9	11.8	13.4	8.9	10.4	5.8	6.6
3'	59.8	62.2	42	43.9	32.5	32.8	48.2	51.5	35.4	37	26.5	28.1	22.9	25.3	18	19.4	11.8	12.6
4'	39	40.5	29	30.2	22.5	23.4	39.1	41.2	30.1	31.4	23.2	24.3	24.9	26.6	19.9	20.8	13.4	13.9
5'	25.2	26.1	19.7	20.5	15.7	16.3	28.9	30.2	23.2	24.1	18.4	19.2	21.9	23.1	17.9	18.6	12.2	12.8
6'	16.7	17.2	13.6	14.2	11.2	11.6	20.8	21.6	17.3	18	14.2	14.8	17.9	18.8	14.9	15.6	10.5	11
7'	11.4	11.7	9.6	10	8.1	8.4	15.1	15.6	12.9	13.4	10.9	11.3	14.2	14.9	12.1	12.6	8.8	9.2
8'	8	8.2	7	7.2	6	6.2	11.1	11.3	9.7	10	8.3	8.7	11.2	11.6	9.8	10.1	7.2	7.5
9'	5.8	5.9	5.2	5.4	4.6	4.7	8.3	8.5	7.4	7.6	6.5	6.7	8.8	9.2	7.8	8.1	6	6.2
10'	4.4	4.4	3.9	4.1	3.5	3.6	6.3	6.4	5.7	5.9	5.1	5.3	7	7.2	6.3	6.5	4.9	5.1

Tunable White (Luminus) Wall Wash 10LM, 95CRI, 3500K																		
MOUNTING DISTANCE	2' FROM WALL						3' FROM WALL						4' FROM WALL					
FIXTURE SPACING	2' ON CENTER		3' ON CENTER		4' ON CENTER		2' ON CENTER		3' ON CENTER		4' ON CENTER		3' ON CENTER		4' ON CENTER		6' ON CENTER	
DISTANCE FROM CEILING	CENTER	MID POINT	CENTER	MID POINT	CENTER	MID POINT	CENTER	MID POINT	CENTER	MID POINT	CENTER	MID POINT	CENTER	MID POINT	CENTER	MID POINT	CENTER	MID POINT
1'	27.7	32.3	18.1	20.5	16.5	11.9	6.4	7.1	4.4	5.2	3.4	3.6	2	2.1	1.5	1.7	1.2	1
2'	62.2	65	41.7	43.4	34.1	30.3	31.1	34.9	21.9	24	15.8	17.8	9.2	10.4	6.9	8.1	4.5	5.1
3'	46.6	48.5	32.8	34.3	25.3	25.6	37.6	40.1	27.6	28.9	20.7	21.9	17.9	19.7	14	15.1	9.2	9.8
4'	30.4	31.6	22.6	23.5	17.5	18.2	30.5	32.1	23.5	24.5	18.1	19	19.4	20.7	15.5	16.2	10.4	10.9
5'	19.7	20.3	15.4	16	12.2	12.7	22.5	23.5	18.1	18.8	14.4	15	17.1	18	13.9	14.5	9.6	10
6'	13	13.4	10.6	11.1	8.7	9	16.3	16.9	13.5	14	11.1	11.5	14	14.7	11.7	12.1	8.2	8.6
7'	8.9	9.1	7.5	7.8	6.3	6.6	11.8	12.1	10.1	10.4	8.5	8.8	11.1	11.6	9.5	9.8	6.8	7.1
8'	6.3	6.4	5.5	5.6	4.7	4.9	8.6	8.8	7.6	7.8	6.5	6.8	8.7	9.1	7.6	7.9	5.6	5.9
9'	4.5	4.6	4	4.2	3.5	3.7	6.4	6.6	5.8	5.9	5.1	5.2	6.9	7.1	6.1	6.3	4.7	4.8
10'	3.4	3.4	3.1	3.2	2.7	2.8	4.9	5	4.5	4.6	4	4.1	5.5	5.6	4.9	5.1	3.8	4

**NOTE**

1. Performance based on typical reflectance values and room dimensions. IES files available at ledbrands.com

PROJECT INFORMATION		
JOB NAME		TYPE
ORDERING CODE		

## PHOTOMETRIC DATA CHARTS - NICHIA

### FOOT CANDLE MEASUREMENT

Tunable White (Nichia) Wall Wash 25LM, 80CRI, 3500K

MOUNTING DISTANCE	2' FROM WALL						3' FROM WALL						4' FROM WALL					
	2' ON CENTER		3' ON CENTER		4' ON CENTER		2' ON CENTER		3' ON CENTER		4' ON CENTER		3' ON CENTER		4' ON CENTER		6' ON CENTER	
FIXTURE SPACING																		
DISTANCE FROM CEILING	CENTER	MID POINT	CENTER	MID POINT	CENTER	MID POINT	CENTER	MID POINT	CENTER	MID POINT	CENTER	MID POINT	CENTER	MID POINT	CENTER	MID POINT	CENTER	MID POINT
1'	59.2	69	38.7	43.8	35.2	25.5	13.8	15.3	9.5	11	7.3	7.8	4.3	4.5	3.2	3.6	2.5	2.2
2'	132.8	138.8	89	92.7	72.8	64.6	66.4	74.5	46.8	51.2	33.7	38.1	19.6	22.3	14.8	17.3	9.7	10.9
3'	99.6	103.6	69.9	73.2	54.1	54.6	80.2	85.7	59	61.7	44.2	46.7	38.2	42.1	29.9	32.2	19.7	20.9
4'	65	67.4	48.3	50.3	37.4	39	65.1	68.6	50.1	52.2	38.6	40.5	41.5	44.3	33.2	34.7	22.3	23.2
5'	42	43.4	32.8	34.2	26.1	27.2	48.1	50.2	38.6	40.1	30.7	32	36.5	38.5	29.8	31	20.4	21.3
6'	27.8	28.6	22.7	23.6	18.6	19.3	34.7	36	28.9	30	23.6	24.6	29.8	31.3	24.9	25.9	17.5	18.3
7'	19	19.4	16	16.7	13.5	14	25.1	25.9	21.5	22.3	18.1	18.8	23.7	24.7	20.2	21	14.6	15.3
8'	13.4	13.7	11.6	12.1	10	10.4	18.4	18.9	16.2	16.7	13.9	14.5	18.7	19.4	16.2	16.9	12.1	12.6
9'	9.7	9.9	8.6	8.9	7.6	7.9	13.7	14.1	12.4	12.7	10.8	11.2	14.7	15.3	13	13.5	9.9	10.4
10'	7.2	7.3	6.6	6.8	5.9	6.1	10.5	10.6	9.5	9.8	8.5	8.8	11.7	12	10.5	10.8	8.2	8.6

Tunable White (Nichia) Wall Wash 20LM, 80CRI, 3500K

MOUNTING DISTANCE	2' FROM WALL						3' FROM WALL						4' FROM WALL					
	2' ON CENTER		3' ON CENTER		4' ON CENTER		2' ON CENTER		3' ON CENTER		4' ON CENTER		3' ON CENTER		4' ON CENTER		6' ON CENTER	
FIXTURE SPACING																		
DISTANCE FROM CEILING	CENTER	MID POINT	CENTER	MID POINT	CENTER	MID POINT	CENTER	MID POINT	CENTER	MID POINT	CENTER	MID POINT	CENTER	MID POINT	CENTER	MID POINT	CENTER	MID POINT
1'	47.7	55.6	31.2	35.3	28.3	20.5	11.1	12.3	7.6	8.9	5.9	6.3	3.5	3.7	2.6	2.9	2	1.8
2'	106.9	111.7	71.7	74.6	58.6	52	53.4	60	37.7	41.2	27.1	30.7	15.8	17.9	11.9	13.9	7.8	8.8
3'	80.2	83.4	56.3	58.9	43.5	44	64.6	69	47.5	49.7	35.6	37.6	30.8	33.9	24.1	25.9	15.9	16.8
4'	52.3	54.3	38.9	40.5	30.1	31.4	52.4	55.2	40.3	42	31.1	32.6	33.4	35.6	26.7	27.9	17.9	18.7
5'	33.8	34.9	26.4	27.5	21	21.9	38.8	40.5	31.1	32.3	24.7	25.8	29.4	31	24	25	16.4	17.2
6'	22.4	23	18.3	19	15	15.5	27.9	29	23.3	24.1	19	19.8	24	25.2	20	20.9	14.1	14.7
7'	15.3	15.6	12.9	13.5	10.9	11.3	20.2	20.9	17.3	18	14.6	15.1	19.1	19.9	16.3	16.9	11.8	12.3
8'	10.8	11	9.4	9.7	8.1	8.4	14.8	15.2	13.1	13.5	11.2	11.7	15	15.6	13.1	13.6	9.7	10.1
9'	7.8	8	7	7.2	6.1	6.3	11.1	11.3	9.9	10.2	8.7	9	11.9	12.3	10.5	10.9	8	8.3
10'	5.8	5.9	5.3	5.4	4.7	4.9	8.4	8.6	7.7	7.9	6.8	7.1	9.4	9.7	8.5	8.7	6.6	6.9

Tunable White (Nichia) Wall Wash 15LM, 80CRI, 3500K | Tunable White (Nichia) Wall Wash 20LM, 80CRI, 3500K

MOUNTING DISTANCE	2' FROM WALL						3' FROM WALL						4' FROM WALL					
	2' ON CENTER		3' ON CENTER		4' ON CENTER		2' ON CENTER		3' ON CENTER		4' ON CENTER		3' ON CENTER		4' ON CENTER		6' ON CENTER	
FIXTURE SPACING																		
DISTANCE FROM CEILING	CENTER	MID POINT	CENTER	MID POINT	CENTER	MID POINT	CENTER	MID POINT	CENTER	MID POINT	CENTER	MID POINT	CENTER	MID POINT	CENTER	MID POINT	CENTER	MID POINT
1'	39.5	46	25.8	29.2	23.5	17	9.2	10.2	6.3	7.4	4.9	5.2	2.9	3	2.2	2.4	1.7	1.5
2'	88.6	92.6	59.4	61.8	48.5	43.1	44.3	49.7	31.2	34.2	22.5	25.4	13.1	14.9	9.9	11.5	6.5	7.3
3'	66.4	69.1	46.7	48.8	36.1	36.4	53.5	57.2	39.4	41.1	29.5	31.2	25.5	28.1	20	21.5	13.1	13.9
4'	43.4	45	32.2	33.5	25	26	43.4	45.8	33.4	34.8	25.8	27	27.7	29.5	22.1	23.1	14.8	15.5
5'	28	29	21.9	22.8	17.4	18.1	32.1	33.5	25.8	26.8	20.5	21.4	24.4	25.7	19.9	20.7	13.6	14.2
6'	18.5	19.1	15.1	15.8	12.4	12.9	23.2	24	19.3	20	15.8	16.4	19.9	20.9	16.6	17.3	11.7	12.2
7'	12.7	13	10.7	11.1	9	9.3	16.7	17.3	14.4	14.9	12.1	12.5	15.8	16.5	13.5	14	9.8	10.2
8'	8.9	9.1	7.8	8	6.7	6.9	12.3	12.6	10.8	11.1	9.3	9.7	12.4	12.9	10.8	11.2	8	8.4
9'	6.5	6.6	5.8	6	5.1	5.2	9.2	9.4	8.2	8.5	7.2	7.5	9.8	10.2	8.7	9	6.6	6.9
10'	4.8	4.9	4.4	4.5	3.9	4	7	7.1	6.4	6.5	5.7	5.9	7.8	8	7	7.2	5.5	5.7

**NOTE**

1. Performance based on typical reflectance values and room dimensions. IES files available at ledbrands.com

PROJECT INFORMATION		
JOB NAME		TYPE
ORDERING CODE		

**PHOTOMETRIC DATA CHARTS - NICHIA**

**FOOT CANDLE MEASUREMENT**

**Tunable White (Nichia) Wall Wash 10LM, 80CRI, 3500K**

MOUNTING DISTANCE	2' FROM WALL						3' FROM WALL						4' FROM WALL					
	2' ON CENTER		3' ON CENTER		4' ON CENTER		2' ON CENTER		3' ON CENTER		4' ON CENTER		3' ON CENTER		4' ON CENTER		6' ON CENTER	
FIXTURE SPACING																		
DISTANCE FROM CEILING	CENTER	MID POINT	CENTER	MID POINT	CENTER	MID POINT	CENTER	MID POINT	CENTER	MID POINT	CENTER	MID POINT	CENTER	MID POINT	CENTER	MID POINT	CENTER	MID POINT
1'	26.8	31.2	17.5	19.8	15.9	11.5	6.2	6.9	4.3	5	3.3	3.5	2	2.1	1.5	1.6	1.1	1
2'	60.1	62.8	40.3	42	32.9	29.3	30	33.7	21.2	23.2	15.3	17.2	8.9	10.1	6.7	7.8	4.4	5
3'	45.1	46.9	31.7	33.1	24.5	24.7	36.3	38.8	26.7	27.9	20	21.2	17.3	19.1	13.6	14.6	8.9	9.5
4'	29.4	30.5	21.8	22.8	16.9	17.6	29.5	31.1	22.7	23.6	17.5	18.3	18.8	20	15	15.7	10.1	10.5
5'	19	19.6	14.9	15.5	11.8	12.3	21.8	22.7	17.5	18.2	13.9	14.5	16.5	17.4	13.5	14	9.2	9.7
6'	12.6	12.9	10.3	10.7	8.4	8.7	15.7	16.3	13.1	13.6	10.7	11.1	13.5	14.2	11.3	11.7	7.9	8.3
7'	8.6	8.8	7.3	7.6	6.1	6.3	11.4	11.7	9.8	10.1	8.2	8.5	10.7	11.2	9.2	9.5	6.6	6.9
8'	6.1	6.2	5.3	5.5	4.5	4.7	8.3	8.6	7.3	7.6	6.3	6.6	8.4	8.8	7.4	7.6	5.5	5.7
9'	4.4	4.5	3.9	4	3.4	3.6	6.2	6.4	5.6	5.8	4.9	5.1	6.7	6.9	5.9	6.1	4.5	4.7
10'	3.3	3.3	3	3.1	2.7	2.7	4.7	4.8	4.3	4.4	3.8	4	5.3	5.5	4.8	4.9	3.7	3.9

**NOTE**

1. Performance based on typical reflectance values and room dimensions. IES files available at ledbrands.com

PROJECT INFORMATION		
JOB NAME		TYPE
ORDERING CODE		

## MOUNTING OPTIONS

### FIXTURE HEIGHT 10LM - 20LM CONFIGURATION

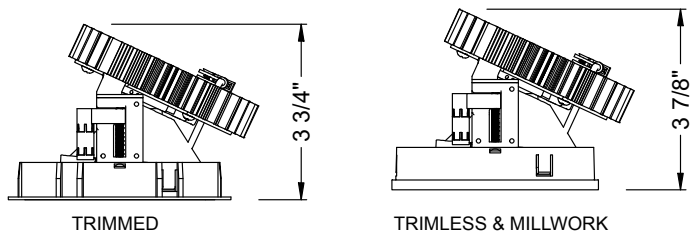

### 25LM CONFIGURATION

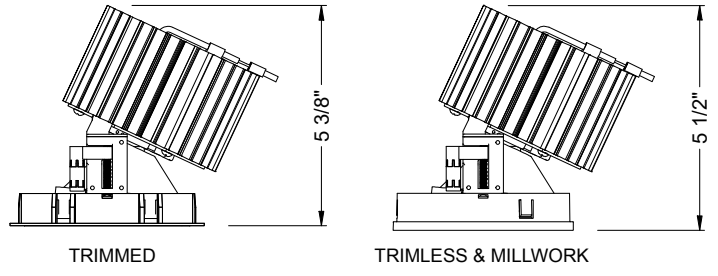

### NC - NEW CONSTRUCTION

#### TRIM

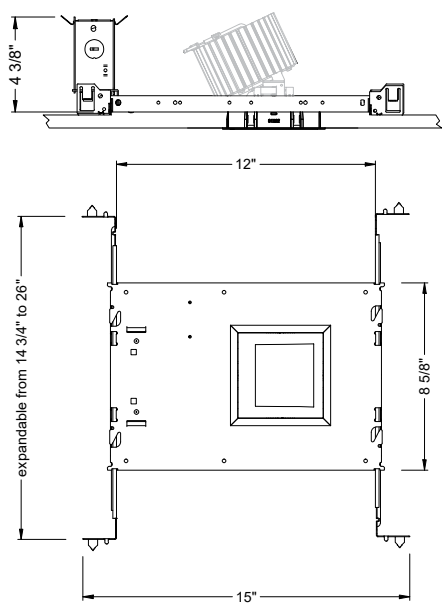

#### TRIM

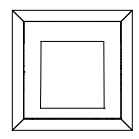

ceiling cutout  
4-1/4" square  
ceiling thickness  
1/8" to 1-1/4"

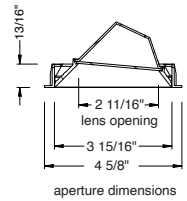

#### TRIMLESS

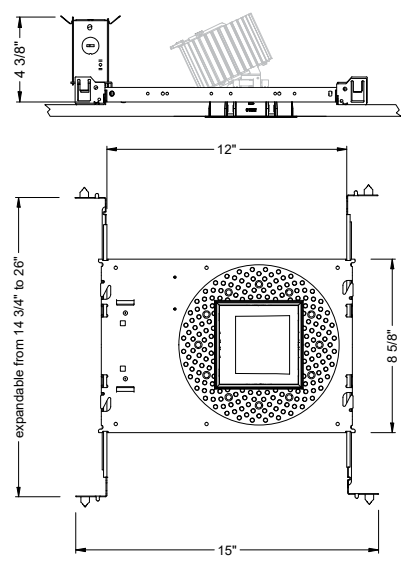

#### TRIMLESS

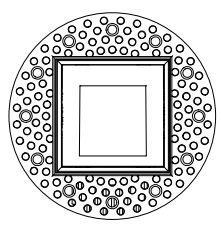

ceiling cutout  
4-1/2" square  
ceiling thickness  
3/8" to 1-1/4"

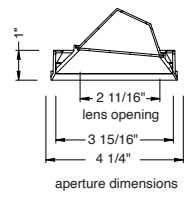

#### TRIMLESS/MILLWORK

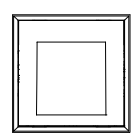

ceiling cutout  
4-1/4" square  
ceiling thickness  
5/8" to 1-1/4"

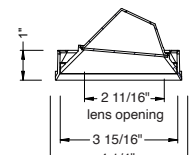



PROJECT INFORMATION		
JOB NAME	TYPE	
ORDERING CODE		

## MOUNTING OPTIONS (CONTINUED)

### RET - RETRO TRIM/TRIMLESS

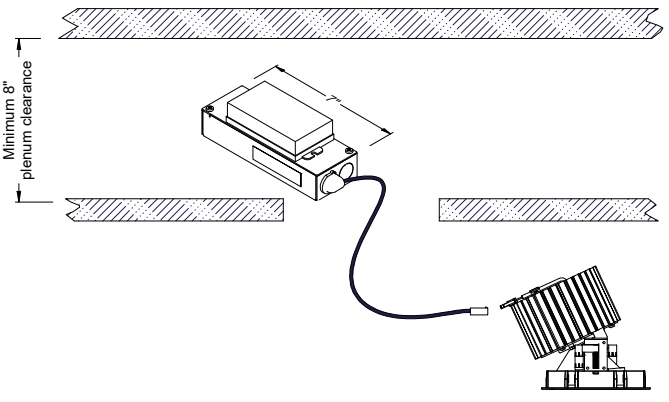

### NC - DRIVER BOX SIZE TRIM/TRIMLESS

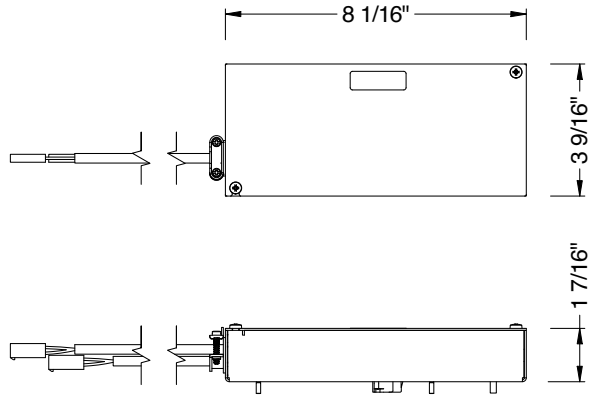

**NOTE:**  
For servicing the driver/j-box, access above ceiling is required. T-Bar type ceilings with removable adjacent tile access recommended. Hard lid ceilings may require access doors directly adjacent to luminaire.

RATINGS / CERTIFICATIONS	NC	RET
TYPE NON-IC	✓	✓
TYPE IC		
CHICAGO PLENUM (CECA)		
SUITABLE FOR AIR HANDLING PLENUMS	✓	✓
REDUCED AIRFLOW (WITH LENS) ASTM E283	✓	✓

CEILING THICKNESS	
FIXTURE TYPE	MOUNTING TYPE
	STANDARD CEILING THICKNESS
TRIM	1/8" to 1-1/4"
TRIMLESS	3/8" to 1-3/4"
MILLWORK (TRIMLESS)	1/2" to 1-3/4"