



Installation Instructions

NU4 & NU6 Tamper Resistant - RD / QD - Downlight / Wall Wash / Adjustable

*Installation Instructions are applicable for other versions.

**WARNING – PLEASE READ ALL INSTRUCTIONS PRIOR TO INSTALLATION
READ AND FOLLOW ALL WARNINGS AND INSTRUCTIONS BEFORE INSTALLING OR MAINTAINING THIS PRODUCT.
TURN OFF POWER PRIOR TO ANY WORK ON THE SYSTEM OR PRODUCT.
DO NOT INSTALL DAMAGED PRODUCT.
AMBIENT TEMPERATURE AT LUMINAIRE LOCATION SHOULD NOT EXCEED 40°C DURING NORMAL OPERATION.**

Installing, wiring, and maintenance must be done by qualified persons or a certified electrician in accordance with all local and National Electrical Codes.

Warranty is voided in case of unauthorized modifications and/or improper use.

Save these instructions. Use as reference when service or maintenance is performed.

CAUTION – For Non – IC fixtures, do not install any fixture assembly closer than 6 inches (15.24cm) from any combustible material (insulation)..

New Construction Mounting Plate driver compartments are rated for through wiring.

Refer to product label for voltage requirements and properly ground fixture in accordance with all local and national electrical codes.

If building and product supports optional dimming, connect dimming leads to dimming control system (provided by others). Refer to product label for dimming requirements. Isolate dimming wires individually if not in use.

Suitable for WET locations.



⚠️ WARNING ⚠️

- To avoid possible electrical shock, before installing light fixtures, disconnect power by turning off the circuit breakers both to the outlet box and to its associated wall switch location. If you cannot lock the circuit breakers in the off position, securely fasten a prominent warning device, such as a tag, to the service panel.
- Verify that supply voltage is correct by comparing it with the luminaire label information.
- Make all electrical and ground connections in the accordance with the National Electrical Code (NEC) and any applicable local code requirements.
- Wait for fixture and driver to cool before servicing and performing maintenance.

⚠️ CAUTION ⚠️

- All wiring must comply with national and local electrical codes and ANSI/NFPA 70. If you are unfamiliar with wiring, consult a qualified electrician.
- PPE Personal Protective Equipment such as gloves and safety glasses should always be used when installing, maintaining or servicing.
- Risk of fire. Keep combustible material away from fixtures.

⚠️ ADVERTENCIA ⚠️

- Para evitar un choque eléctrico, antes de instalar luminarias, desconecte la alimentación apagando los interruptores de circuito en el panel de servicio y en las paredes. Si no es posible bloquear los interruptores en la posición de apagado, sujete una etiqueta de seguridad en el panel de servicio.
- Compruebe que la tensión de alimentación es correcta comparándola con la información en la etiqueta de la luminaria.
- Haga todas las conexiones eléctricas y puesta a tierra de acuerdo con el código eléctrico nacional (NEC) y los requisitos del código local aplicable.
- Espere hasta que la luminaria y el controlador se enfríen antes de empezar el servicio y mantenimiento.

⚠️ PRECAUCION ⚠️

- Todo el cableado debe cumplir con los códigos eléctricos nacionales y locales y ANSI/NFPA 70. Si no está familiarizado con el cableado, consulte a un electricista.
- Al instalar, mantener o reparar, siempre se debe utilizar equipo de protección personal como guantes y lentes de seguridad
- Riesgo de incendio. Mantenga los materiales combustibles lejos de las luminarias.

⚠️ AVERTISSEMENT ⚠️

- Pour éviter les chocs, avant d'installer des appareils d'éclairage, coupez l'alimentation en désactivant les disjoncteurs et l'emplacement du commutateur mural. Si vous ne pouvez pas verrouiller les disjoncteurs en position d'arrêt, fixer un avertissement sur le panneau de service.
- Vérifiez que la tension d'alimentation est correcte en le comparant avec les informations d'étiquette de luminaire.
- Effectuer tous les raccordements électriques et mise à la terre dans la conformité avec le Code électrique National (NEC) et des exigences du code local applicable.
- Laisser suffisamment de temps pour l'appareil et pilote refroidir avant d'effectuer l'entretien et la maintenance.

⚠️ MIS EN GARDE ⚠️

- Tout le câblage doit être effectué conformément aux codes électriques locaux et nationaux et ANSI/NFPA 70. Si vous êtes peu familier avec câblage, vous devez utiliser un électricien qualifié.
- Équipement de protection personnelle comme des gants et des lunettes de sécurité doivent être utilisés en tout temps lors de l'installation, maintenance ou entretien.
- Risque d'incendie. Garder les matières combustibles loin de luminaires.

INSTRUCTIONS FOR USE

De-energize circuit before installation.

STEP 1A - EXISTING CEILING:

Ensure placement of fixture will accommodate New Construction Mounting Plate and LED Module Assembly. Refer to product cut sheet and cut hole into ceiling. Adjust bar hangers to size and secure New Construction Mounting Plate as required using integral nails and screws or suspend in T- Bar grid ceiling. Ensure the fixture is properly supported and attached to building. Open wiring compartment and use knockouts to connect electrical conduit to wiring compartment using appropriate hardware (not provided). Connect line, neutral, and ground wires to building electrical supply. Close driver compartment.

STEP 1B - NEW CONSTRUCTION:

Secure New Construction Mounting Plate by adjusting bar hangers to size and secure New Construction Mounting Plate as required using integral nails and screws or suspend in T-Bar grid ceiling. Ensure the fixture is properly supported and attached to building. Refer to product cut sheet and cut hole into ceiling as required. Open wiring compartment and use knockouts to connect electrical conduit to wiring compartment using appropriate hardware (not provided). Connect line, neutral, and ground wires to building electrical supply. Close driver compartment.

STEP 1C - RETROFIT:

New Construction Mounting Plate not used. Ensure area above finished ceiling will accommodate placement of fixture and driver compartment. Refer to product cut sheet and cut hole into ceiling as required. Feed building electrical conduit through ceiling cutout and ensure enough conduit length for future serviceability. Open driver compartment and use knockouts to connect building electrical conduit to driver compartment using appropriate hardware (not provided). Connect line, neutral, and ground wires to building electrical supply. Close driver compartment. For fixture servicing, do not fasten driver compartment.

STEP 2 - FIXTURE INSTALLATION:

1. Carefully remove bezel from LED Module Assembly. Use hand to pull bezel away from LED Module Assembly. Sharp or flat objects not recommended as they can damage the bezel or snap locks. For bezel with lens, a suction cup is provided to remove bezel for future servicing.
2. Place mounting ring over the fixture allowing for the trim to be seated into the groove of the mounting ring.
3. Connect the quick disconnect from driver compartment to LED Module Assembly.
4. Insert the LED Module Assembly through the ceiling cutout.
5. Ensure the LED Module Assembly is securely fastened against the ceiling but has not recessed into soft ceiling tiles due to over tightening.
6. Carefully insert bezel into LED Module Assembly. Press firmly until bezel snaps into place.
7. Once fixture is secured to plenum cover, Place lens into metal bezel. Align all four holes then Insert a tamper resistant screw to aid with securing of the metal mounting ring. Fasten all four screws hand tight.
8. Energize circuit and test for proper operation.

Applicable for all trimmed NU4 & NU6 products

1

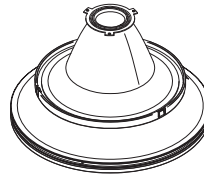
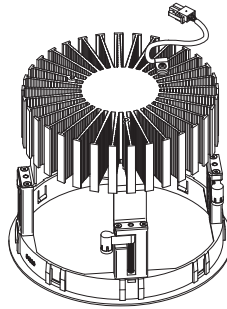

2

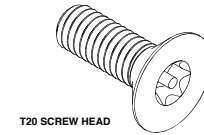
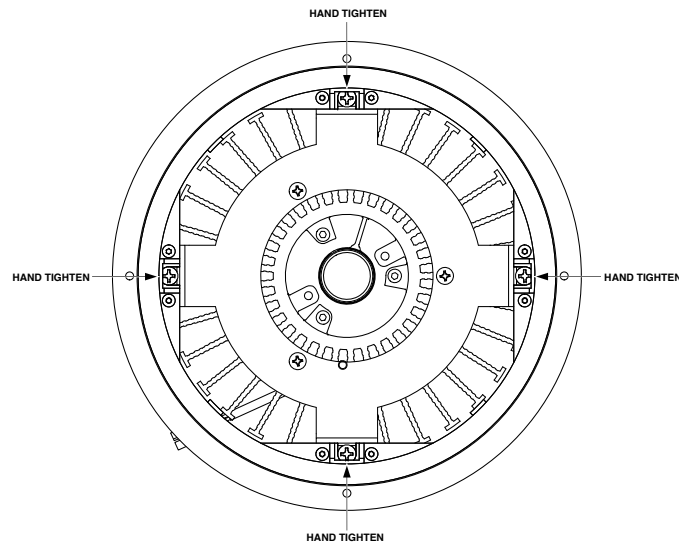
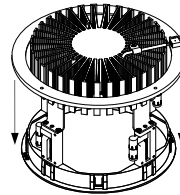

T20 SCREW HEAD

IMPORTANT

BIT / TIP TYPE		USE
TORX	TORX	OK ✓
STANDARD	SQUARE	'DO NOT USE' ✗
	TORX	

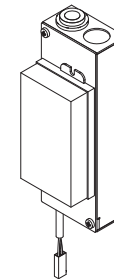

RETROFIT VERSION

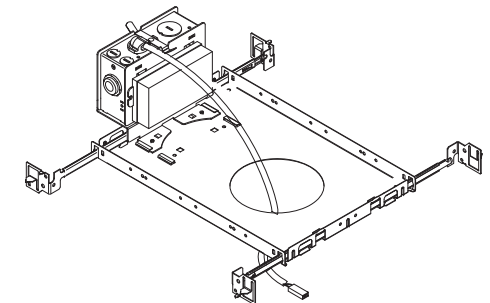

*NEW CONSTRUCTION MOUNTING PLATE NOT FOR USE WITH RETROFIT

INSTRUCTIONS FOR INSTALLING OPTIC, ACCESSORIES AND BEZEL

