

PROJECT INFORMATION		
JOB NAME		TYPE
ORDERING CODE		

NU3

3" Square Wall Wash Tunable White

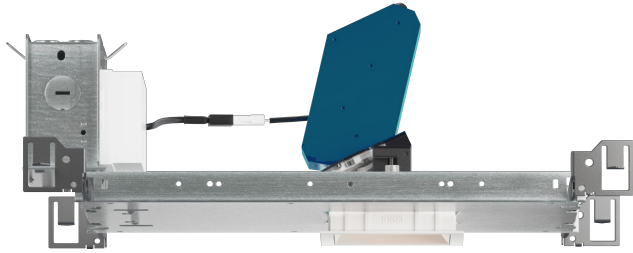

WW BEAM		
(Note: Specifications are subject to change without notice)		
14mm COB PERFORMANCE DATA LUMINUS		
LED LIGHT ENGINE	NOMINAL DELIVERED LUMENS	SYSTEM WATTAGE
10LM	820LM @35K/95CRI	15W
15LM	1250LM @35K/95CRI	25W
Note	Delivered lumens based on WW optic with no lens, (see page 2)	

WW BEAM		
(Note: Specifications are subject to change without notice)		
14mm COB PERFORMANCE DATA NICHIA		
LED LIGHT ENGINE	NOMINAL DELIVERED LUMENS	SYSTEM WATTAGE
10LM	1050LM @35K/80CRI	13W
15LM	1510LM @35K/80CRI	19W
20LM	1850LM @35K/80CRI	25W
Note	Delivered lumens based on WW optic with no lens, (see page 2)	



Trim

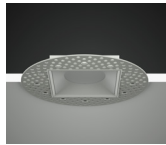

Trimless



Trimless Millwork

FEATURES

- An asymmetric reflector with highly efficient BrightView angle bending lens produces excellent wall washing with no scalloping
- 4' set back with 6' on center spacing - 15 FC average
- 3/4" bezel regress with 1/16" micro flange
- Custom finishes available
- Microban antimicrobial finish available on all exposed painted surfaces

DIMMING AND CONTROLS

- eldoLED flicker free 0-10V dimming to 0% and 1%
- eldoLED flicker free DALI dimming to 0% and 1%
- Casambi bluetooth dimming to 0%
- Nlight control interface dimming to 0%

CONSTRUCTION

- Lexan™ (PC) highly resistant to impact and heat (240°F)
- Optimal material for wireless BLE signal connectivity
- Shatter proof acrylic bezel lens
- Electrocoated 16-gauge cold-rolled steel construction
- Accommodates ceiling thickness from 1/8" to 1-3/8"
- For servicing the driver/j-box, access above ceiling is required

LED

- Luminus tunable white COB: 95 CRI, R9 > 70; SDCM = 4-step MacAdam Ellipse; Lumen Maintenance: L₇₀ > 54,000 hrs
- Nichia tunable white COB: 80 CRI, R9 > 0; SDCM = 3-step MacAdam Ellipse; Lumen Maintenance: L₉₀ > 33,000 hrs

LISTING

- ULus Listed to UL1598 & UL2108; cUL Listed to CSA C22.2 #250.0
- IP65 with lens - Suitable for wet locations with lens - Suitable for damp locations without lens
- Non-conductive, dead-front construction (shower approved)
- NSF/ANSI-2 with lens (Non-Food and Splash Zones)
- 5 Year Limited warranty

ELECTRICAL

- 120V-277V, 120 only Triac / ELV
- Power factor ≥ 0.9
- 2kV driver input surge protection
- Max. ambient installation temperature 95°F (35°C)

FIXTURE HEIGHT

LOW LUMENS 10LM - 15LM

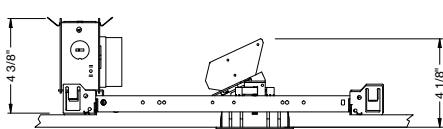

HIGH LUMENS 20LM

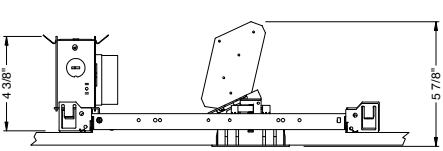

TRIMMED

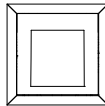

ceiling cutout
3-1/4" square
ceiling thickness
1/8" to 1-1/4"

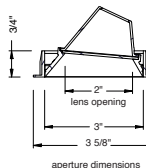

TRIMLESS

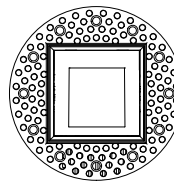

ceiling cutout
3-1/2" square
ceiling thickness
3/8" to 1-3/8"

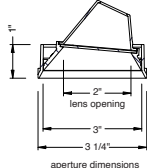

MILLWORK

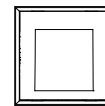

ceiling cutout
3-9/32" square
ceiling thickness
5/8" to 1-3/8"

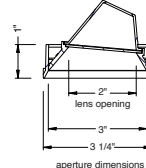

alphabet

PROJECT INFORMATION		
JOB NAME		TYPE
ORDERING CODE		

WW BEAM ORDERING CODE																																																	
SERIES	NU3 NU3																																																
TYPE	QWT square wall wash trimless QW square wall wash QWTMW square wall wash trimless millwork																																																
LED	TW tunable white (Luminus)																																																
DELIVERED LUMENS	10LM 820 lm 15LM 1250 lm Standard Configuration: 3500K 95CRI Calculated Delivered Lumens = [Delivered Lumen Value] x [CCT Multiplier]																																																
CCT	2765 2700K to 6500K tunable white <table border="1"> <thead> <tr> <th>CCT</th> <th>2700K</th> <th>3000K</th> <th>3500K</th> <th>4000K</th> <th>5000K</th> <th>5700K</th> <th>6500K</th> </tr> </thead> <tbody> <tr> <td>CCT MULTIPLIER FOR LUMEN OUTPUT</td> <td>0.91</td> <td>0.98</td> <td>1.00</td> <td>0.99</td> <td>1.00</td> <td>1.01</td> <td>1.02</td> </tr> <tr> <td>EML RATIO</td> <td>0.49</td> <td>0.57</td> <td>0.68</td> <td>0.79</td> <td>0.96</td> <td>1.04</td> <td>1.12</td> </tr> </tbody> </table> 1840 1800K to 4000K tunable white <table border="1"> <thead> <tr> <th>CCT</th> <th>1800K</th> <th>2000K</th> <th>2400K</th> <th>2700K</th> <th>3000K</th> <th>3500K</th> <th>4000K</th> </tr> </thead> <tbody> <tr> <td>CCT MULTIPLIER FOR LUMEN OUTPUT</td> <td>0.67</td> <td>0.74</td> <td>0.8</td> <td>0.85</td> <td>0.88</td> <td>0.95</td> <td>1.01</td> </tr> <tr> <td>EML RATIO</td> <td>0.21</td> <td>0.33</td> <td>0.46</td> <td>0.53</td> <td>0.59</td> <td>0.67</td> <td>0.73</td> </tr> </tbody> </table>	CCT	2700K	3000K	3500K	4000K	5000K	5700K	6500K	CCT MULTIPLIER FOR LUMEN OUTPUT	0.91	0.98	1.00	0.99	1.00	1.01	1.02	EML RATIO	0.49	0.57	0.68	0.79	0.96	1.04	1.12	CCT	1800K	2000K	2400K	2700K	3000K	3500K	4000K	CCT MULTIPLIER FOR LUMEN OUTPUT	0.67	0.74	0.8	0.85	0.88	0.95	1.01	EML RATIO	0.21	0.33	0.46	0.53	0.59	0.67	0.73
CCT	2700K	3000K	3500K	4000K	5000K	5700K	6500K																																										
CCT MULTIPLIER FOR LUMEN OUTPUT	0.91	0.98	1.00	0.99	1.00	1.01	1.02																																										
EML RATIO	0.49	0.57	0.68	0.79	0.96	1.04	1.12																																										
CCT	1800K	2000K	2400K	2700K	3000K	3500K	4000K																																										
CCT MULTIPLIER FOR LUMEN OUTPUT	0.67	0.74	0.8	0.85	0.88	0.95	1.01																																										
EML RATIO	0.21	0.33	0.46	0.53	0.59	0.67	0.73																																										
CRI	95 95 typical, 90 minimum																																																
OPTIC & LM MULTIPLIER SEE PAGE 4	WW wall wash with diffused angle bending lens																																																
TRIM COLOR	BK black WH white MC matte chrome BZ bronze WT wheat CC¹ custom color, consult factory for details Antimicrobial finish, add AM to black, white or matte chrome i.e. BKAM. Not applicable to trimless option. Do not include in trimless ordering code.																																																
BEZEL COLOR	BK black (0.98) WH white (1.00) MC matte chrome (0.99) BZ bronze (0.98) WT wheat (0.99) CC¹ custom color, consult factory for details Antimicrobial finish, add AM to black, white or matte chrome i.e. BKAM.																																																

WW BEAM ORDERING CODE	
MOUNTING OPTIONS SEE PAGE 6, 7	NC new construction with ceiling fitting plate RET retrofit, no ceiling fitting plate For servicing the driver/j-box access above ceiling is required.
VOLTAGE	120 120V UNV 120V-277V
DIMMING	DIM10Z² eldoLED flicker free 0-10V dimming to 0% DALIZ eldoLED flicker free DALI dimming to 0% NLT nLight control interface: standard Cat-5/RJ45 connection (female), dimming to 0% CASZ Casambi Bluetooth dim to zero

ADDITIONAL MOUNTING INFO	
New Construction Bar Hangers (included)	Mounting Length: 14-3/4" to 26"
Extension Kit p/n: K20266 (ordered separately, 1 per fixture)	Extends a pair of Bar Hangers Total Mounting Length: 29" to 48"

YOUR COMPLETED ORDERING CODE	
Follow the steps to specify your fixture, example:	
NU3 - QW - TW - 10LM - 2765 - 95 - WW - WH - WH - NC - UNV - DIM10	

NOTES

1. Custom set up fee plus minimum quantity required per color.
2. Requires 2 wall controllers (see wiring diagram).

* EML = equivalent melanopic lux. To calculate EML, multiply the measured photopic lux by the EML ratio for the given CCT. Example: 254 lux x 0.79 = 200 melanopic lux at 4000K.

TRIM OPTIONS

TRIM/BEZEL COLORS

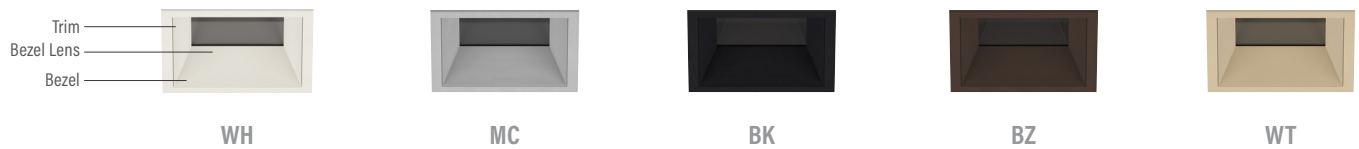

alphabet

PROJECT INFORMATION		
JOB NAME		TYPE
ORDERING CODE		

NICHIA TUNABLE WHITE - ORDERING CODE							
SERIES	NU3	NU3					
TYPE	QW	square wall wash					
	QWT	square wall wash trimless					
	QWTMW	square wall wash trimless millwork					
LED	TW	tunable white (Nichia)					
DELIVERED LUMENS	10LM	1050 lm					
	15LM	1510 lm					
	20LM	1850 lm					
Standard Configuration: 3500K 80CRI Calculated Delivered Lumens = [Delivered Lumen Value] x [CCT Multiplier]							
CCT	2750	2700K to 5000K tunable white					
		CCT	2700K	3000K	3500K	4000K	5000K
		EML RATIO	0.43	0.51	0.63	0.69	0.80
CRI	80	80 CRI					
OPTIC & LM MULTIPLIER SEE PAGE 5	WW	wall wash with diffused angle bending lens					
TRIM COLOR	BK	black					
	WH	white					
	MC	matte chrome					
	BZ	bronze					
	WT	wheat					
	CC¹	custom color, consult factory for details					
Antimicrobial finish, add AM to black, white or matte chrome i.e. BKAM.							
Not applicable to trimless option. Do not include in trimless ordering code.							
BEZEL COLOR	BK	black	(0.98)				
	WH	white	(1.00)				
	MC	matte chrome	(0.99)				
	BZ	bronze	(0.98)				
	WT	wheat	(0.99)				
	CC¹	custom color, consult factory for details					
Antimicrobial finish, add AM to black, white or matte chrome i.e. BKAM.							

NICHIA TUNABLE WHITE - ORDERING CODE		
MOUNTING OPTIONS SEE PAGE 6, 7	NC	new construction with ceiling fitting plate
	RET	retrofit, no ceiling fitting plate
For servicing the driver/j-box access above ceiling is required.		
VOLTAGE	120	120V
	UNV	120V-277V
DIMMING	DIM10Z²	eldoLED flicker free 0-10V dimming to 0%
	DALIZ	eldoLED flicker free DALI dimming to 0%
	NLT	nLight control interface: standard Cat-5/RJ45 connection (female), dimming to 0%
	CASZ	Casambi Bluetooth dim to zero

ADDITIONAL MOUNTING INFO	
New Construction Bar Hangers (included)	Mounting Length: 14-3/4" to 26"
Extension Kit p/n: K20266 (ordered separately, 1 per fixture)	Extends a pair of Bar Hangers Total Mounting Length: 29" to 48"

YOUR COMPLETED ORDERING CODE
Follow the steps to specify your fixture, example:
NU3 - QW - TW - 10LM - 2750 - 80 - WW - WH - WH - NC - UNV - DIM10

NOTES

1. Custom set up fee plus minimum quantity required per color.
2. Requires 2 wall controllers (see wiring diagram).

*EML = equivalent melanopic lux. To calculate EML, multiply the measured photopic lux by the EML ratio for the given CCT.
Example: 290 lux x 0.69 = 200 melanopic lux at 4000K.

TRIM OPTIONS

TRIM/BEZEL COLORS

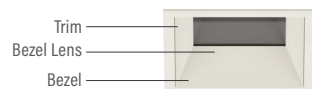

WH



MC



BK

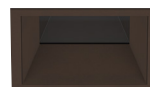

BZ



WT

alphabet

PROJECT INFORMATION		
JOB NAME		TYPE
ORDERING CODE		

PHOTOMETRIC DATA DIAGRAM

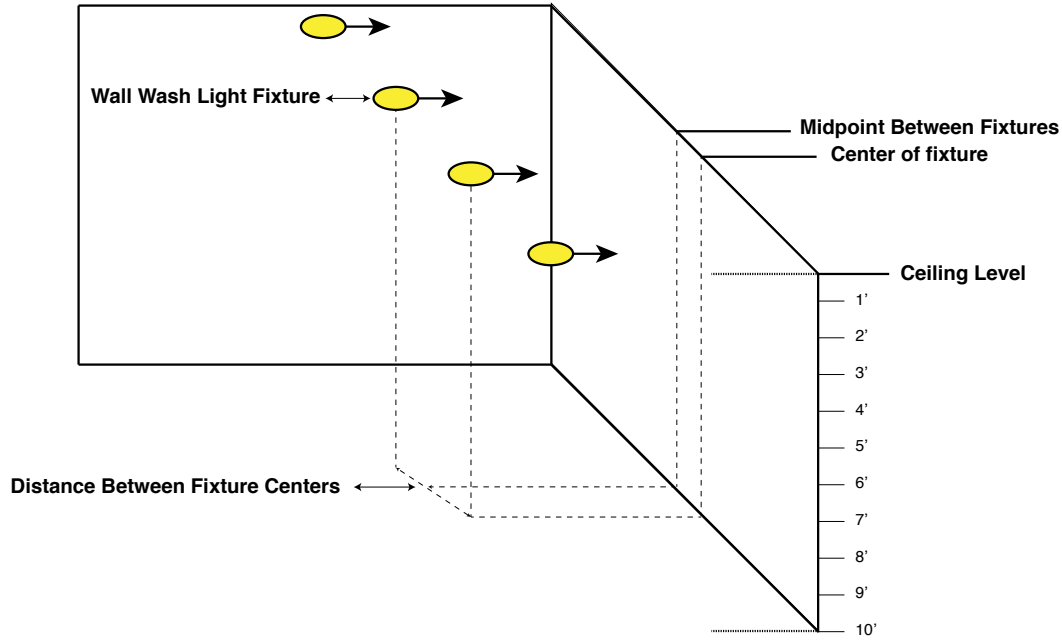

PHOTOMETRIC DATA CHARTS LUMINUS

TUNABLE WHITE WALL WASH 15LM, 95CRI, 3500K																		
Mounting Distance	2' from wall						3' from wall						4' from wall					
Fixture Spacing	2' on center		3' on center		4' on center		2' on center		3' on center		4' on center		3' on center		4' on center		6' on center	
Distance from Ceiling	Center	Mid Point	Center	Mid Point	Center	Mid Point	Center	Mid Point	Center	Mid Point	Center	Mid Point	Center	Mid Point	Center	Mid Point	Center	Mid Point
1'	15	18	10	12	9	6	5	5	3	4	3	3	2	2	1	1	1	1
2'	62	66	39	46	32	33	18	20	12	15	8	12	5	5	4	5	3	3
3'	63	65	43	46	33	35	37	42	28	29	20	23	12	13	9	11	5	8
4'	45	47	33	34	25	26	39	42	30	31	23	24	19	21	16	17	10	12
5'	31	32	23	25	19	19	32	34	25	26	20	21	21	22	17	18	11	12
6'	21	21	17	17	14	14	24	25	20	21	16	17	19	20	16	16	11	11
7'	15	15	12	13	10	10	18	19	15	16	13	13	16	17	13	14	10	10
8'	10	11	9	9	8	8	14	14	12	12	10	11	13	14	11	12	8	9
9'	8	8	7	7	6	6	10	11	9	10	8	8	11	11	9	10	7	7
10'	6	6	5	5	4	5	8	8	7	7	6	7	9	9	8	8	6	6

TUNABLE WHITE WALL WASH 10LM, 95CRI, 3500K																		
Mounting Distance	2' from wall						3' from wall						4' from wall					
Fixture Spacing	2' on center		3' on center		4' on center		2' on center		3' on center		4' on center		3' on center		4' on center		6' on center	
Distance from Ceiling	Center	Mid Point	Center	Mid Point	Center	Mid Point	Center	Mid Point	Center	Mid Point	Center	Mid Point	Center	Mid Point	Center	Mid Point	Center	Mid Point
1'	9	11	7	7	6	4	3	3	2	2	2	2	1	1	1	1	1	1
2'	39	42	24	29	20	21	12	13	8	9	5	8	3	3	2	3	2	2
3'	40	41	27	29	21	22	24	26	17	18	12	14	8	8	6	7	3	5
4'	28	29	21	22	16	17	25	26	19	20	14	15	12	13	10	10	6	7
5'	19	20	15	15	12	12	20	21	16	17	12	13	13	14	11	11	7	8
6'	13	13	10	11	8	9	15	16	13	13	10	11	12	13	10	10	7	7
7'	9	9	8	8	6	7	11	12	10	10	8	8	10	11	8	9	6	6
8'	7	7	6	6	5	5	9	9	8	8	6	7	8	9	7	7	5	5
9'	5	5	4	4	4	4	7	7	6	6	5	5	7	7	6	6	4	5
10'	4	4	3	3	3	3	5	5	5	5	4	4	5	6	5	5	4	4

NOTE

1. Performance based on typical reflectance values and room dimensions. IES files available at ledrbrands.com

PROJECT INFORMATION		
JOB NAME		TYPE
ORDERING CODE		

PHOTOMETRIC DATA CHARTS NICHIA

FOOT CANDLE MEASUREMENT

TUNEABLE WHITE WALL WASH 20LM, 80CRI, 3500K																		
Mounting Distance	2' from wall						3' from wall						4' from wall					
Fixture Spacing	2' on center		3' on center		4' on center		2' on center		3' on center		4' on center		3' on center		4' on center		6' on center	
Distance from Ceiling	Center	Mid Point	Center	Mid Point	Center	Mid Point	Center	Mid Point	Center	Mid Point	Center	Mid Point	Center	Mid Point	Center	Mid Point	Center	Mid Point
1'	21	25	14	16	13	9	7	8	5	5	4	4	2	2	2	2	1	1
2'	86	91	53	64	43	45	25	28	17	20	11	17	7	7	5	6	4	4
3'	87	90	59	63	46	48	52	57	38	40	27	32	17	18	13	15	7	11
4'	62	64	45	47	35	36	54	58	41	43	31	33	27	29	21	23	13	16
5'	42	44	32	34	26	26	44	46	35	36	27	29	29	31	24	25	16	17
6'	29	30	23	24	19	19	34	35	28	29	22	23	26	28	22	22	15	16
7'	20	21	17	17	14	14	25	26	21	22	18	18	22	23	19	19	13	14
8'	14	15	12	13	10	11	19	20	16	17	14	14	18	19	15	16	11	12
9'	11	11	9	10	8	8	14	15	13	13	11	11	15	15	13	13	10	10
10'	8	8	7	7	6	6	11	11	10	10	9	9	12	12	11	11	8	8

TUNEABLE WHITE WALL WASH 15LM, 80CRI, 3500K																		
Mounting Distance	2' from wall						3' from wall						4' from wall					
Fixture Spacing	2' on center		3' on center		4' on center		2' on center		3' on center		4' on center		3' on center		4' on center		6' on center	
Distance from Ceiling	Center	Mid Point	Center	Mid Point	Center	Mid Point	Center	Mid Point	Center	Mid Point	Center	Mid Point	Center	Mid Point	Center	Mid Point	Center	Mid Point
1'	16	19	11	12	10	7	5	6	4	4	3	3	2	2	1	1	1	1
2'	66	70	41	49	34	35	20	21	13	16	9	13	5	6	4	5	3	3
3'	67	70	46	49	35	37	40	44	29	31	21	24	13	14	10	11	6	8
4'	48	50	35	37	27	28	42	45	32	33	24	26	21	23	17	18	10	12
5'	33	34	25	26	20	20	34	36	27	28	21	22	22	24	18	19	12	13
6'	22	23	18	19	14	15	26	27	21	22	17	18	20	21	17	17	12	12
7'	16	16	13	13	11	11	19	20	16	17	14	14	17	18	14	15	10	11
8'	11	11	9	10	8	8	15	15	13	13	11	11	14	15	12	12	9	9
9'	8	8	7	7	6	6	11	11	10	10	9	9	11	12	10	10	7	8
10'	6	6	5	6	5	5	9	9	8	8	7	7	9	9	8	8	6	7

TUNEABLE WHITE WALL WASH 10LM, 80CRI, 3500K																		
Mounting Distance	2' from wall						3' from wall						4' from wall					
Fixture Spacing	2' on center		3' on center		4' on center		2' on center		3' on center		4' on center		3' on center		4' on center		6' on center	
Distance from Ceiling	Center	Mid Point	Center	Mid Point	Center	Mid Point	Center	Mid Point	Center	Mid Point	Center	Mid Point	Center	Mid Point	Center	Mid Point	Center	Mid Point
1'	11	13	8	8	7	5	4	4	2	3	2	2	1	1	1	1	1	1
2'	45	48	28	34	23	24	13	15	9	11	6	9	4	4	3	3	2	2
3'	46	47	31	33	24	25	27	30	20	21	14	17	9	10	7	8	4	6
4'	33	34	24	25	18	19	28	30	22	23	16	18	14	15	11	12	7	8
5'	22	23	17	18	13	14	23	24	18	19	14	15	15	16	12	13	8	9
6'	15	16	12	13	10	10	18	18	15	15	12	12	14	15	11	12	8	8
7'	11	11	9	9	7	8	13	14	11	12	9	10	12	12	10	10	7	7
8'	8	8	6	7	5	6	10	10	9	9	7	8	9	10	8	8	6	6
9'	6	6	5	5	4	4	8	8	7	7	6	6	8	8	7	7	5	5
10'	4	4	4	4	3	3	6	6	5	5	5	5	6	6	6	6	4	4

NOTE

1. Performance based on typical reflectance values and room dimensions. IES files available at ledrabrands.com

PROJECT INFORMATION		
JOB NAME		TYPE
ORDERING CODE		

MOUNTING OPTIONS

FIXTURE HEIGHT

10LM - 30 LM LOW LUMENS

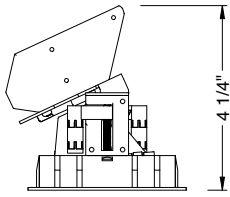

TRIMMED

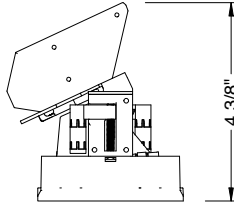

TRIMLESS & MILLWORK

35LM - 40 LM HIGH LUMENS

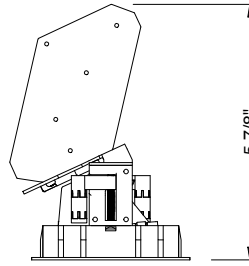

TRIMMED

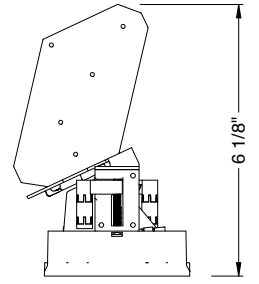

TRIMLESS & MILLWORK

NC - NEW CONSTRUCTION

TRIM

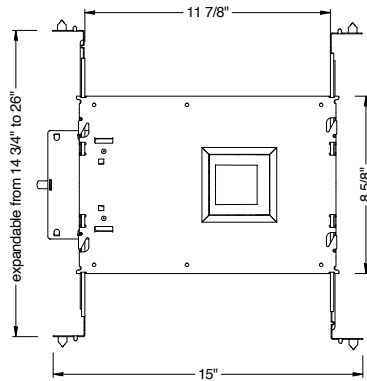
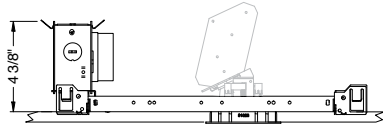

TRIM

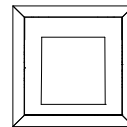

ceiling cutout
3-1/4" square
ceiling thickness
1/8" to 1-1/4"

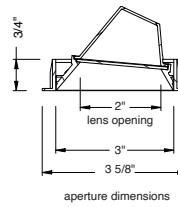

aperture dimensions

TRIMLESS

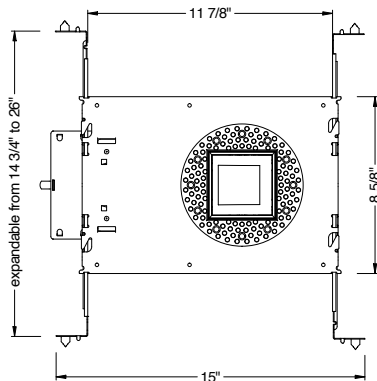
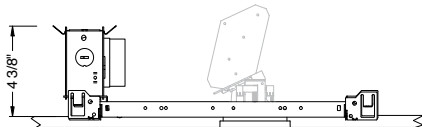

TRIMLESS

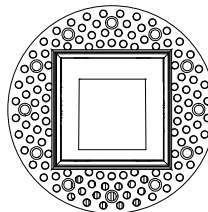

ceiling cutout
3-1/2" square
ceiling thickness
3/8" to 1-3/8"

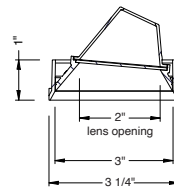

aperture dimensions

TRIMLESS/MILLWORK

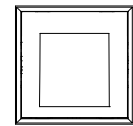

ceiling cutout
3-9/32" square
ceiling thickness
5/8" to 1-3/8"

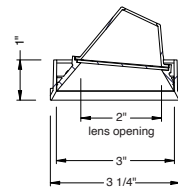

aperture dimensions

PROJECT INFORMATION		
JOB NAME	TYPE	
ORDERING CODE		

MOUNTING OPTIONS

RET - RETRO TRIM/TRIMLESS

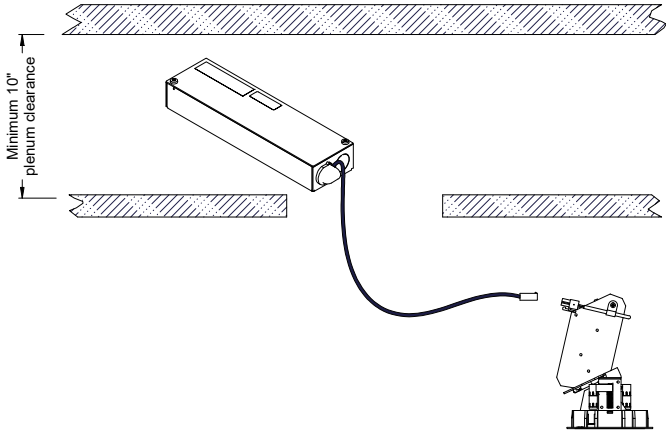

NC - DROVER BOX SIZE TRIM/TRIMLESS

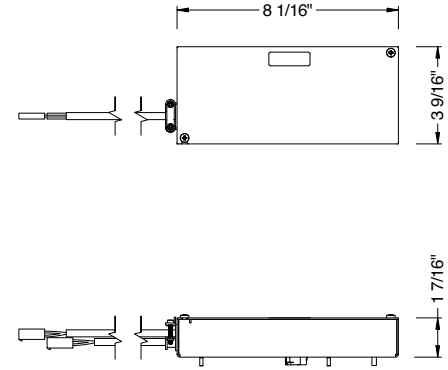

NOTE

For servicing the driver/j-box, access above ceiling is required. T-Bar type ceilings with removable adjacent tile access recommended. Hard lid ceilings may require access doors directly adjacent to luminaire.

RATINGS / CERTIFICATIONS	NC	RET
TYPE NON-IC	✓	✓
TYPE IC		
CHICAGO PLENUM (CCEA)		
SUITABLE FOR AIR HANDLING PLENUMS		
REDUCED AIRFLOW (WITH LENS) ASTM E283	✓	✓

CEILING THICKNESS	
FIXTURE TYPE	MOUNTING TYPE
	CEILING THICKNESS
TRIM	1/8" to 1-1/4"
TRIMLESS	3/8" to 1-3/8"
MILLWORK (TRIMLESS)	5/8" to 1-3/8"

PROJECT INFORMATION		
JOB NAME	TYPE	
ORDERING CODE		

TUNABLE WHITE

LUMINUS 95CRI

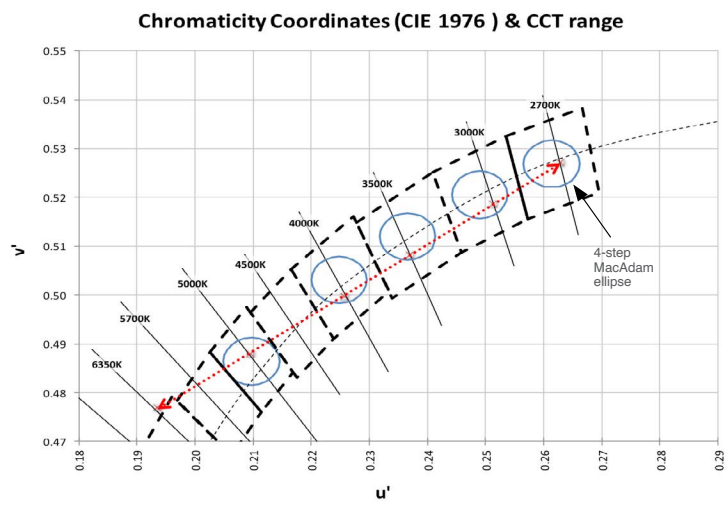

NICHIA 80CRI

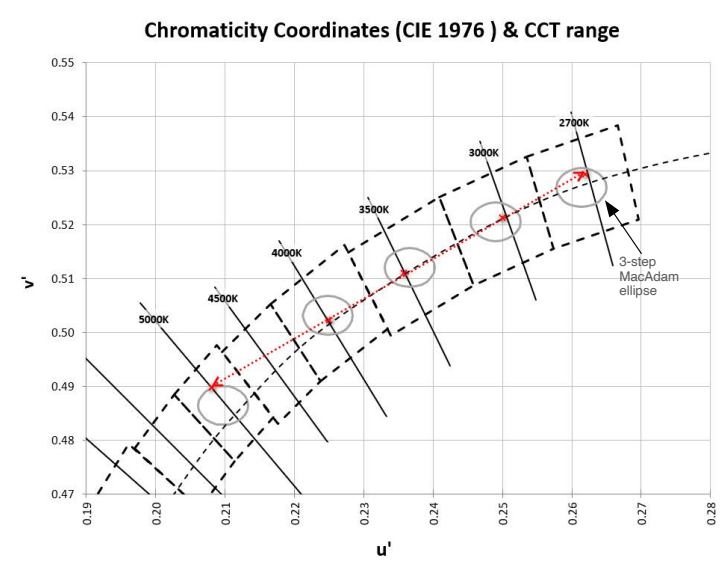

WIRING DIAGRAMS

“CAS” CASAMBI CONTROLS

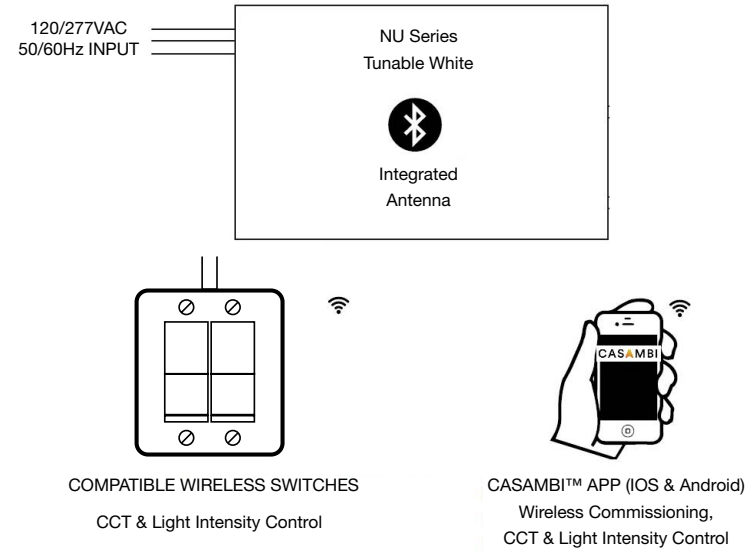

“DIM10Z” HARDWIRED 0-10V CONTROL

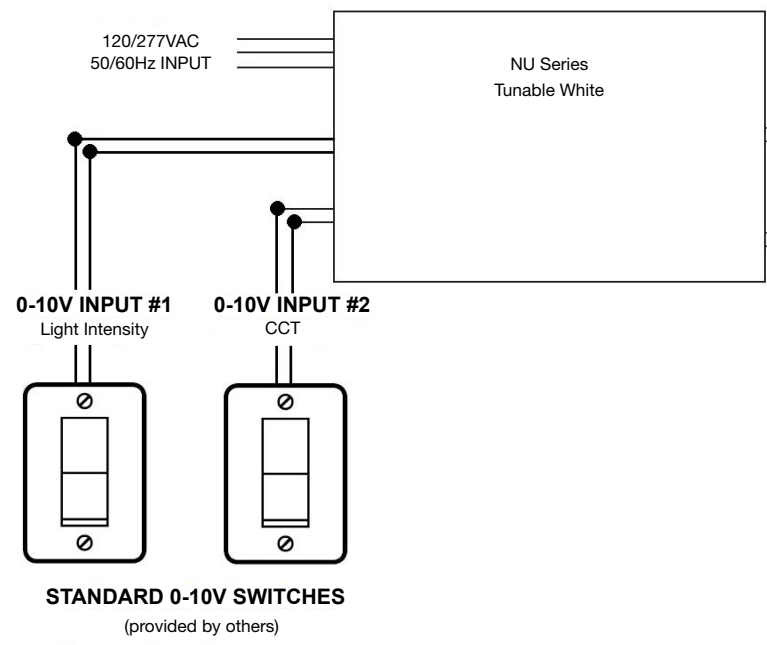

NOTES

- 1 Consult factory to order compatible wireless switches.