

PROJECT INFORMATION		
JOB NAME		TYPE
ORDERING CODE		

## NU1

### 1" Square Deep Regress Warm Dim



25° - 45° BEAM (Note: Specifications are subject to change without notice)			
9mm COB PERFORMANCE DATA			
LED LIGHT ENGINE	NOMINAL DELIVERED LUMENS	DRIVE CURRENT	LED WATTAGE
05LM	440LM @30K/97CRI	175mA	6.5W
07LM	680LM @30K/97CRI	275mA	10W
Notes	Delivered lumens based on 45D optic with no lens, (see page 2)		



eldoLED  
your product | our area



Trim

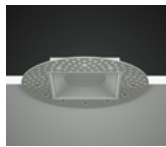

Trimless



Trimless Millwork

#### FEATURES

- 3/4" bezel regress with 1/16" micro flange
- 25° - 45° optical beam control
- UGR < 19
- Up to 60 LPW
- Glare control, specialty optics, trim options, and custom finishes available
- Microban® antimicrobial finish available on all exposed painted surfaces

#### DIMMING AND CONTROLS

- eldoLED flicker free 0-10V dimming to 0% and 1%
- eldoLED flicker free DALI 2 dimming to 0% and 1%
- Lutron Hi-lumen 2-Wire (Eco System) dimming to 0.1% and 1%
- Leading & trailing edge (Triac/ELV) dimming to 1%
- All driver offerings are remote with above ceiling access, see page 3 for details.
- Refer to DX remote panels for additional options.

#### CONSTRUCTION

- High-grade die-cast and cold forged aluminum alloy assembly that has superior thermal and corrosion resistance properties.
- Shatter proof acrylic bezel lens
- Electrocoated 16-gauge cold-rolled steel construction
- Accommodates ceiling thickness from 1/8" to 1-1/2", On-field thick ceiling adjustment

#### LED

- Luminus Dim-to-warm COB:  
97 CRI: SDCM = 3-step MacAdam Ellipse, Lumen Maintenance: L<sub>70</sub> > 54,000 hrs

#### LISTING

- ULus Listed to UL1598 & UL2108; cUL Listed to CSA C22.2 #250.0
- IP44 with lens - Suitable for wet locations with lens - Suitable for damp locations without lens
- NSF/ANSI-2 with lens (Non-Food and Splash Zones)
- 5 Year Limited warranty

#### ELECTRICAL

- Low voltage luminaire: 36Vdc nominal
- 05LM - 175mA
- 07LM - 275mA

#### FIXTURE HEIGHT

LED LIGHT ENGINE: 05LM - 07LM

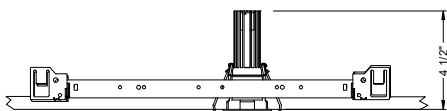

#### TRIMMED

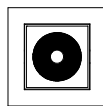

ceiling cutout  
1-3/4" square  
ceiling thickness  
1/8" to 1 1/2"

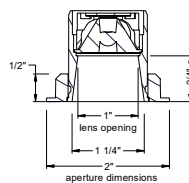

#### TRIMLESS

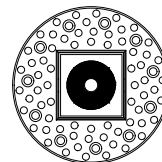

ceiling cutout  
1-3/4" square  
ceiling thickness  
1/8" to 1 1/2"

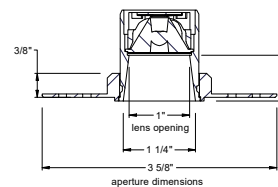

#### MILLWORK



ceiling cutout  
1-7/16" square  
ceiling thickness  
1/8" to 1 1/2"

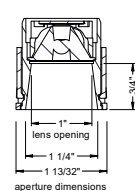

# alphabet

PROJECT INFORMATION		
JOB NAME		TYPE
ORDERING CODE		

ORDERING CODE		
<b>SERIES</b>	<b>NU1</b>	NU1
<b>TYPE</b>	<b>QDDR</b>	square downlight deep regress
	<b>QDDRT</b>	square downlight deep regress trimless
	<b>QDDRTMW</b>	square downlight deep regress trimless millwork
<b>LED</b>	<b>WD</b>	warm dim (Luminus)
<b>DELIVERED LUMENS</b>	<b>05LM</b>	440 lm
	<b>07LM</b>	680 lm
Standard Configuration: 3000K 97CRI 45D, NL Calculated Delivered Lumens = [Delivered Lumen Value] x [Optic Multiplier] x [Lens Multiplier]		
<b>CCT</b>	<b>3018</b>	3000K, dim to 1800K
		CCT at Light Level (%LF)
		%LF   07LM   05LM
		100%   3000   3000
		50%   3000   3000
		25%   2800   2800
10%   2200   2200		
5%   1800   1800		
<b>CRI</b>	<b>97</b>	97 CRI
<b>OPTIC &amp; LM MULTIPLIER</b> SEE PAGE 6	<b>25D<sup>1</sup></b>	25 degrees (0.88)
	<b>35D</b>	35 degrees (0.90)
	<b>40D</b>	40 degrees (0.92)
	<b>45D</b>	45 degrees (1.00)
<b>BEZEL LENS</b> SEE PAGE 5	<b>NL<sup>2</sup></b>	no lens (1.00)
	<b>CL</b>	clear lens (0.92)
	<b>DL</b>	diffused lens (0.80)
	<b>HCL</b>	honeycomb louver (0.58)
	<b>HET</b>	high efficiency textured lens, similar to Solite™ (0.90)
	<b>SBL</b>	smoothing beam lens (0.91)
Maximum 2pcs of media per fixture.		
<b>TRIM COLOR</b> SEE PAGE 5	<b>BK</b>	black
	<b>WH</b>	white
	<b>MC</b>	matte chrome
	<b>BZ</b>	bronze
	<b>WT</b>	wheat
	<b>CC<sup>3</sup></b>	custom color, consult factory for details
Antimicrobial finish, add <b>AM</b> to black, white or matte chrome i.e. BKAM.		
Not applicable to trimless option. Do not include in trimless ordering code.		
<b>BEZEL COLOR</b> SEE PAGE 5	<b>BK</b>	black (0.98)
	<b>WH</b>	white (1.00)
	<b>MC</b>	matte chrome (0.99)
	<b>BZ</b>	bronze (0.98)
	<b>WT</b>	wheat (0.99)
	<b>CC<sup>3</sup></b>	custom color, consult factory for details
Antimicrobial finish, add <b>AM</b> to black, white or matte chrome i.e. BKAM.		

ORDERING CODE		
<b>MOUNTING OPTIONS</b> SEE PAGE 7, 8	<b>NC</b>	new construction with ceiling fitting plate
	<b>NCINH<sup>4</sup></b>	new construction with ceiling fitting plate, IC rated, inherently protected
	<b>IC<sup>5,6</sup></b>	insulation contact housing
	<b>ICAT<sup>5,6</sup></b>	insulation contact/airtight housing
	<b>CP<sup>5,6</sup></b>	chicago plenum housing
	<b>RET</b>	retrofit, no ceiling fitting plate
	<b>RETINH<sup>4</sup></b>	retrofit, no ceiling fitting plate, IC rated, inherently protected
	remote driver only	
<b>VOLTAGE</b>	<b>LVL</b>	low voltage luminaire
<b>DIMMING</b>	<b>ND</b>	No driver included. See page 3 for remote driver options.

YOUR COMPLETED ORDERING CODE	
Follow the steps to specify your fixture, example:	
<b>NU1 - QDDR - WD - 07LM - 3018 - 97 - 25D - HET - WH - WH - NC - LVL - ND</b>	

## NOTES

- 25D available with DL, HET lens option.
- NL option does not meet requirements for AT/WET/NSF listings.
- Custom set up fee plus minimum quantity required per color.
- NCINH, RETINH available in 05LM.
- IC/ICAT/CP not available in 07LM.
- IC/ICAT/CP not available in QDDRTMW.

# alphabet

PROJECT INFORMATION		
JOB NAME		TYPE
ORDERING CODE		

REMOTE DRIVER - ORDERING CODE		
<b>SERIES</b>	<b>DX-C</b>	compact driver box
<b>NUMBER OF DRIVERS</b>	<b>1-5</b>	number of drivers, 1-5
<b>CURRENT</b>	<b>175</b>	175mA
	<b>275</b>	275mA
<b>VOLTAGE</b>	<b>120</b>	120V
	<b>UNV</b>	120V-277V
<b>DIMMING</b>	<b>DIM10</b>	eldoLED flicker free 0-10V dimming to 1%
	<b>DIM10Z</b>	eldoLED flicker free 0-10V dimming to 0%
	<b>DALI</b>	eldoLED flicker free DALI 2 dimming to 1%
	<b>DALIZ</b>	eldoLED flicker free DALI 2 dimming to 0%
	<b>DMX-RJ45<sup>1</sup></b>	DMX control dimming to 0.1% with RJ45 connection
	<b>DMX-WL<sup>1</sup></b>	DMX control dimming to 0.1% with wire lead connection
	<b>DMX-XLR<sup>1</sup></b>	DMX control dimming to 0.1% with XLR 5pin connection
	<b>LUT</b>	Lutron Hi-lume Ecosystem dimming to 1%, Soft-on & Fade-to-Black
	<b>LUTP</b>	Lutron Hi-lume Premier Ecosystem dimming to 0.1%, Soft-on & Fade-to-Black
	<b>ELV<sup>2</sup></b>	leading & trailing edge (Triac/ELV) dimming to 1%
<b>NLT</b>	nLight control interface: standard Cat-5/RJ45 connection (female), dim to off	
<b>CAS<sup>3</sup></b>	Casambi Bluetooth control with flicker free 1% dimming	
<b>AWN<sup>4</sup></b>	lutron athena wireless node	
<b>ELECTRICAL OPTIONS</b>	<b>EM7<sup>5</sup></b>	Remote emergency battery backup, 90 minutes at 7 watts to LED, Remote TS

25° - 45° BEAM		
(Note: Specifications are subject to change without notice)		
9mm COB PERFORMANCE DATA		
LED LIGHT ENGINE	NOMINAL DELIVERED LUMENS	SYSTEM WATTAGE
05LM	440LM @30K/97CRI	8W
07LM	680LM @30K/97CRI	12W
Notes	Delivered lumens based on 45D optic with no lens, (see page 2)	

## ELECTRICAL/CONTROLS

- 120V-277V, 120 only Triac / ELV
- Power factor ≥ 0.9
- 2kV driver input surge protection
- Remote emergency test switch
- 7W, 10W (T20 CEC) and 12W EM 90min battery
- Max. ambient installation temperature 95°F (35°C)
- Minimum wire gauge approved mounting distance 18 AWG, 330 feet
- Maximum Remote mounting distance of EM driver shall be 50 feet

## REMOTE SINGLE DRIVER BOX

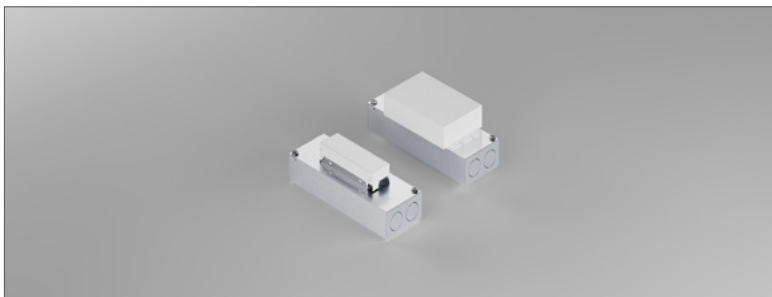

## REMOTE 2 TO 3 DRIVER BOX (2 Drivers for DIM10Z/DALI/DALIZ/LUT/LUTP) (1 Driver + EM)

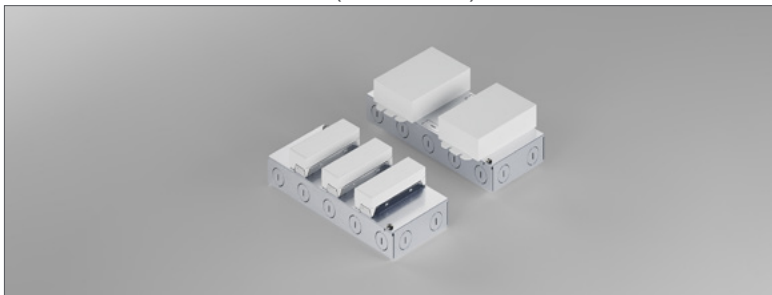

## REMOTE 4 TO 5 DRIVER BOX (3 Drivers for DIM10Z/DALI/DALIZ/LUT/LUTP)

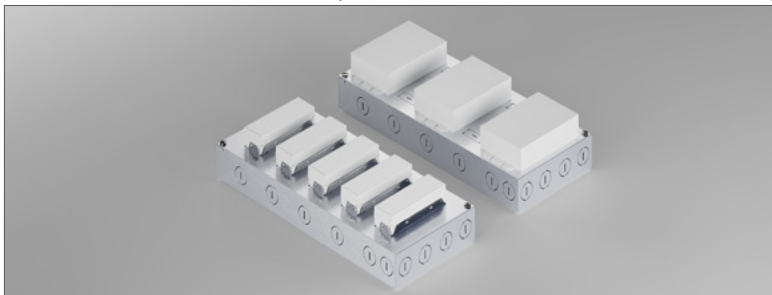

## YOUR COMPLETED ORDERING CODE

Follow the steps to specify your fixture, example:
<b>DX-C - 1 - 275 - UNV - DIM10 - EM7</b>

## NOTES

1. DMX available only in DX-C-1.
  2. ELV available in 120V.
  3. All drivers on single Casambi dimming circuit.
  4. AWNR reference page 10. for product specification on Athena wireless node.
  5. EM available only with DX-C-1. Box size same as DX-C-2, with one driver and one battery.
- \* EldoLED uses logarithmic dimming curve as standard. For linear dimming curve, add "LIN" after dimming code, i.e. DIM10LIN.

PROJECT INFORMATION		
JOB NAME		TYPE
ORDERING CODE		

## DRIVER BOXES

### REMOTE SINGLE DRIVER BOX

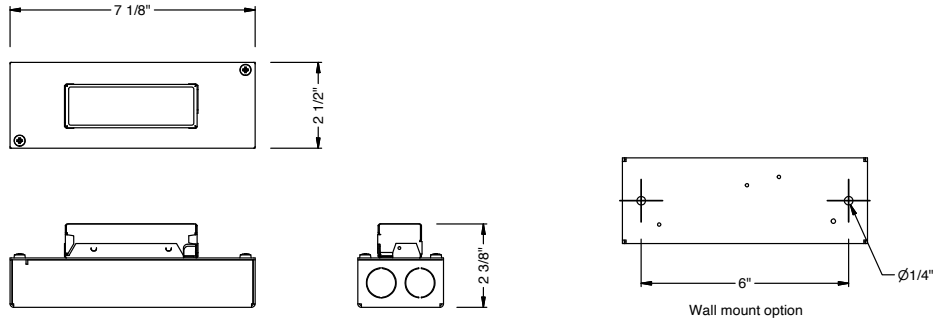

### REMOTE 2 TO 3 DRIVER BOX (2 Drivers for DIM10Z/DALI/DALIZ/LUT/LUTP)

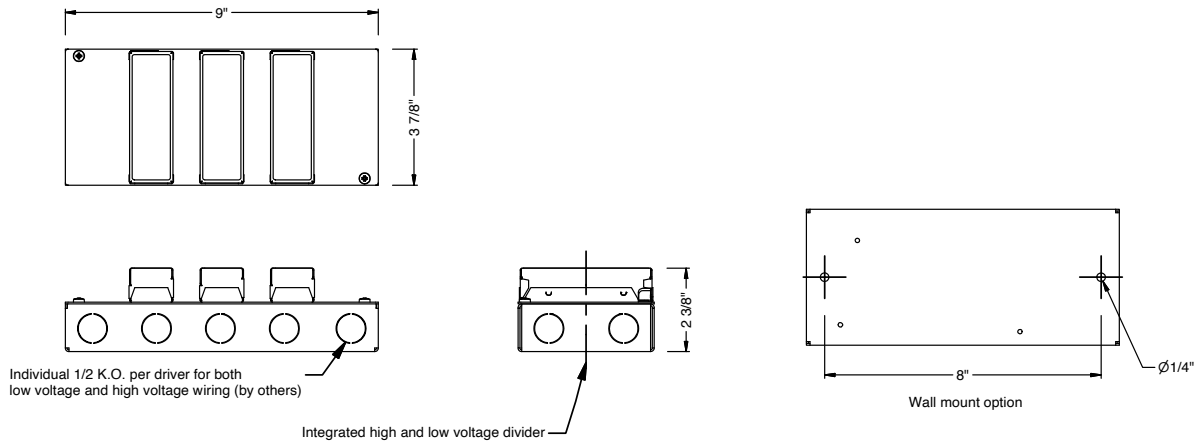

### REMOTE 4 TO 5 DRIVER BOX (3 Drivers for DIM10Z/DALI/DALIZ/LUT/LUTP)

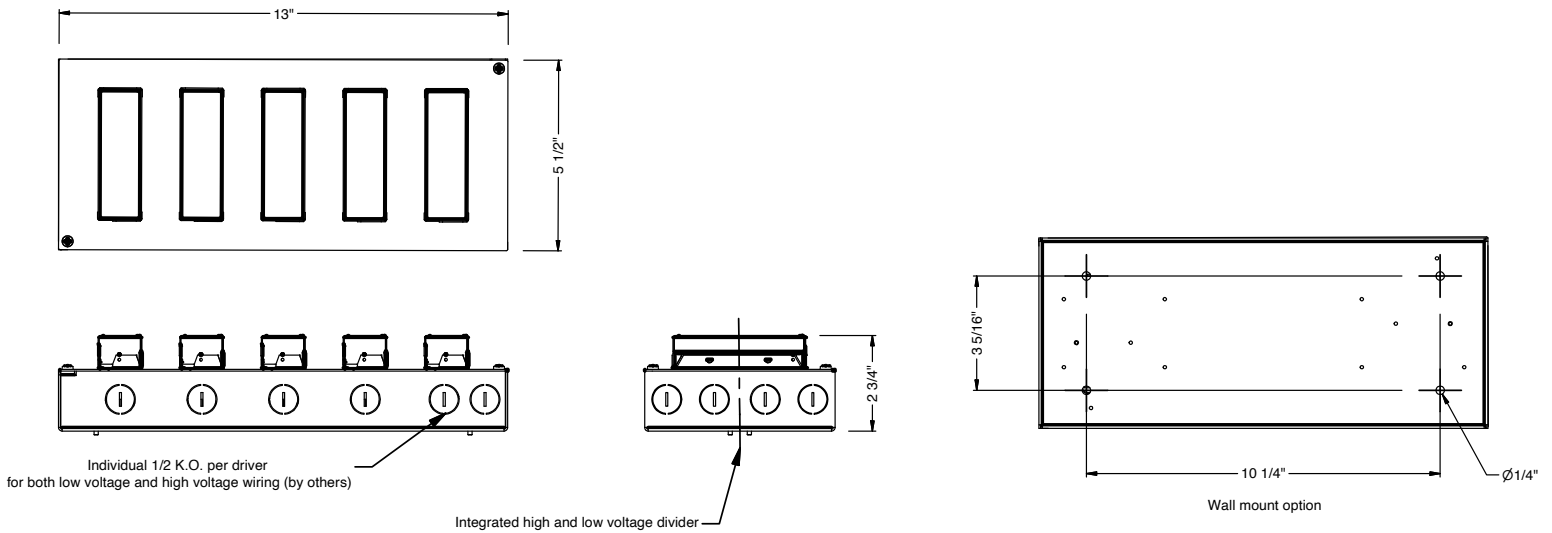

# alphabet

PROJECT INFORMATION			
JOB NAME		TYPE	
ORDERING CODE			

## TRIM OPTIONS

### TRIM/BEZEL COLORS



WH



MC



BK



BZ



WT

## OPTICAL OPTIONS

- UGR calculation based on CIE 117-1995; room size: 4H X 8H, reflectance: 70/50/20;
- UGR calculation based on 07LM BK bezel fixtures, unless otherwise noted.

### HCL

Honeycomb Louver

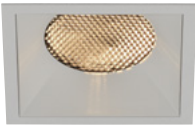

OPTIC	BEAM ANGLE	UGR
35D	30.5	11.1
40D	34.9	15.5
45D	35	16.5

### NL

No Lens



OPTIC	BEAM ANGLE	UGR	UGR15LM
35D	35	15	
40D	40.5	17.1	
45D	44.2	20.3	

### CL

Clear Lens



OPTIC	BEAM ANGLE	UGR
35D	34	14.5
40D	40	16.7
45D	43.1	20

### DL

Diffused Lens



OPTIC	BEAM ANGLE	UGR
25D	36.4	15.5
35D	41.7	18.7
40D	43.2	19.5
45D	47.9	21.8

### HET

High Efficiency Textured Lens



OPTIC	BEAM ANGLE	UGR
25D	27.2	10.8
35D	35	14.5
40D	38.9	18
45D	43.1	19.8

### SBL

Smoothing Beam Lens



OPTIC	BEAM ANGLE	UGR
25D	26.5	10.8
35D	34	14.7
40D	39.5	18
45D	42.8	20

## GLARE CONTROL

### CUT-OFF ANGLE

Visual comfort is achieved with a lower cut-off angle due to improved glare control. The smaller the cut-off angle, the easier it is on the eye.

Alphabet downlights have been thoughtfully engineered to eliminate glare while still delivering functional illumination.

- Cut-off angle of NL and CL is 38°

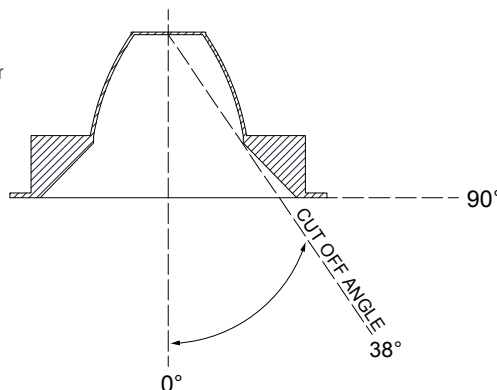

# alphabet

PROJECT INFORMATION		
JOB NAME		TYPE
ORDERING CODE		

## PHOTOMETRIC DATA

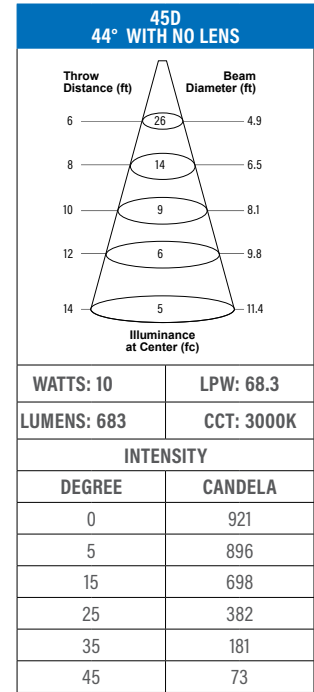
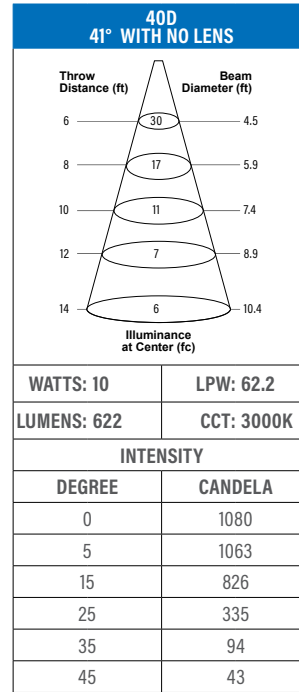
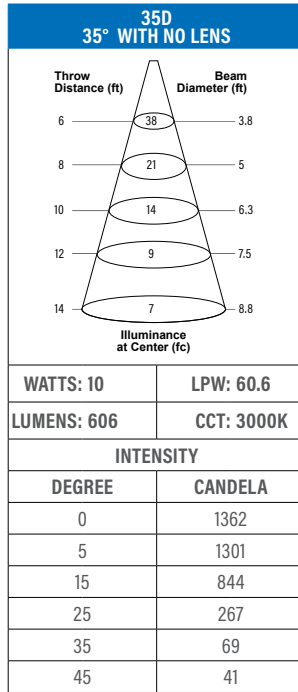
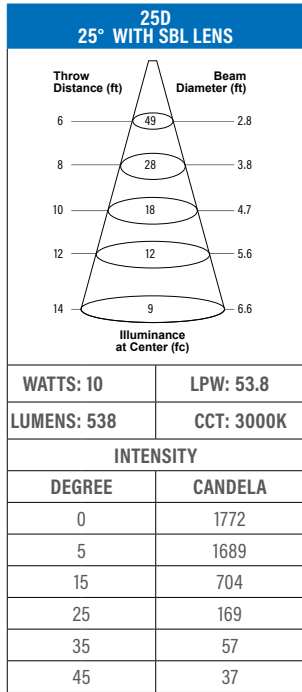
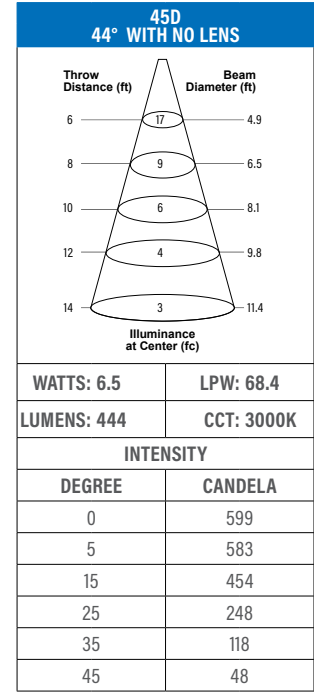
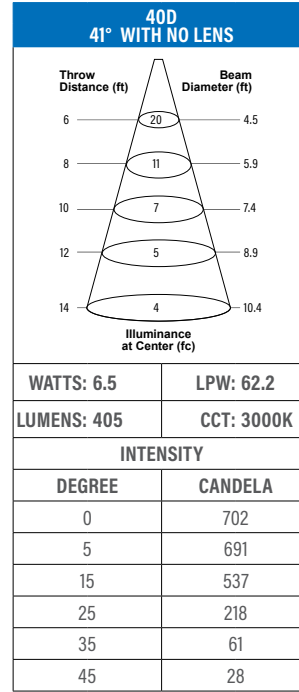
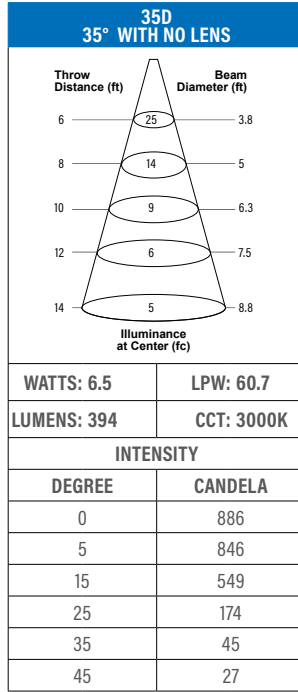
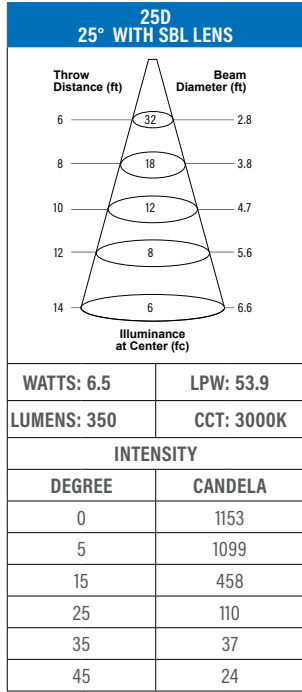

PROJECT INFORMATION		
JOB NAME		TYPE
ORDERING CODE		

## MOUNTING OPTIONS

### FIXTURE HEIGHT

LED LIGHT ENGINE: 05 - 07LM

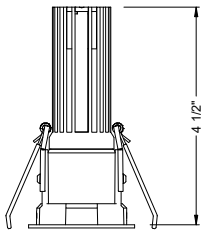

TRIMMED, TRIMLESS & MILLWORK

### NC - NEW CONSTRUCTION

#### TRIM

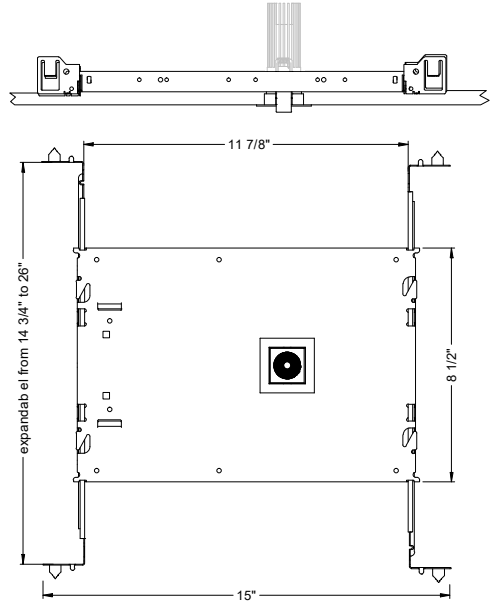

#### TRIM

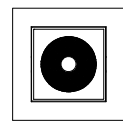

ceiling cutout  
1-3/4" square  
ceiling thickness  
1/8" to 1 1/2"

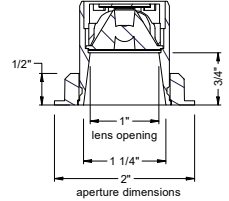

ADDITIONAL MOUNTING INFO	
New Construction Bar Hangers (included)	Mounting Length: 14-3/4" to 26"
Extension Kit p/n: K20266 (ordered separately, 1 per fixture)	<i>Extends a pair of Bar Hangers</i> Total Mounting Length: 29" to 48"

#### TRIMLESS

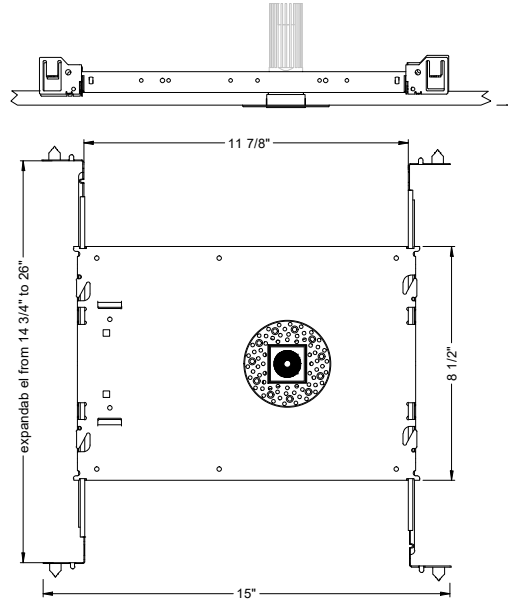

#### TRIMLESS

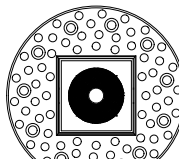

ceiling cutout  
1-3/4" square  
ceiling thickness  
1/8" to 1 1/2"

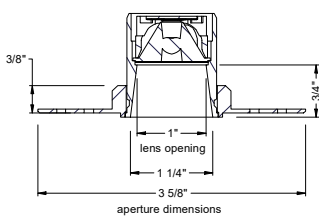

#### TRIMLESS/MILLWORK



ceiling cutout  
1-7/16" square  
ceiling thickness  
1/8" to 1 1/2"

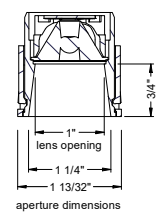

PROJECT INFORMATION		
JOB NAME		TYPE
ORDERING CODE		

## MOUNTING OPTIONS

### RET - RETRO TRIM/TRIMLESS

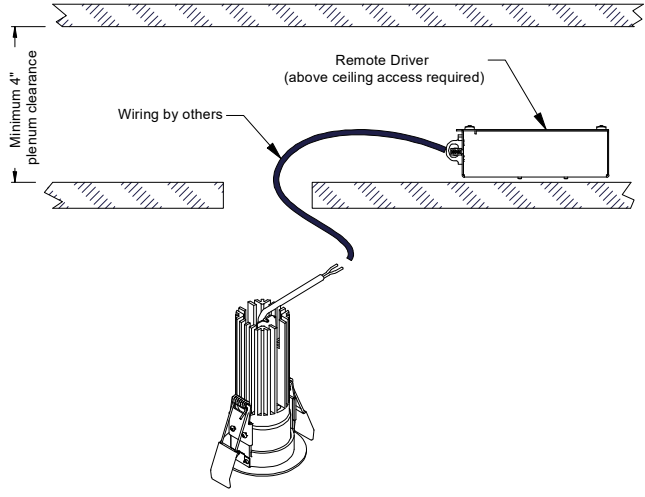

### IC - INSULATION CONTACT HOUSING ICAT - INSULATION CONTACT / AIR TIGHT CP - CHICAGO PLENUM

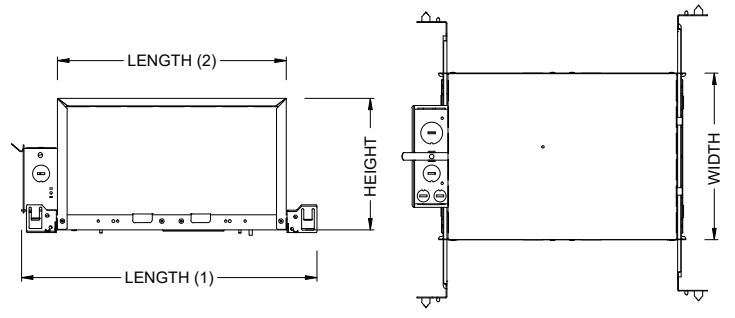

BOX SIZE	L1	L2	W	H
A	15 - 7/16"	11 - 3/4"	8 - 1/2"	6 - 3/4"

RATINGS / CERTIFICATIONS	NC	RET	IC	ICAT	CP
TYPE NON-IC	✓	✓			
TYPE IC			✓	✓	✓
CHICAGO PLENUM (CCEA)					✓
SUITABLE FOR AIR HANDLING PLENUMS				✓	✓
REDUCED AIRFLOW ASTM E283				✓	✓

BOX TYPE / LUMEN OUTPUT - STANDARD BEAMS			
LUMEN OUTPUT	BOX-A		
	CP	IC	ICAT
05LM	✓	✓	✓
07LM			

CEILING THICKNESS			
FIXTURE TYPE	MOUNTING TYPE		
	NC, IC, ICAT, CP, RET	NC, IC, ICAT, CP, RET	NC, IC, ICAT, CP, RET
	STANDARD CEILING THICKNESS	THICK CEILING THICKNESS	CEILING CUTOUT
TRIM	1/8" to 1.0"	1.0" to 1 1/2"	1-3/4" square
TRIMLESS	1/8" to 1.0"	1.0" to 1 1/2"	1-3/4" square
MILLWORK (TRIMLESS)	1/8" to 1.0"	1.0" to 1 1/2"	1-7/16" square

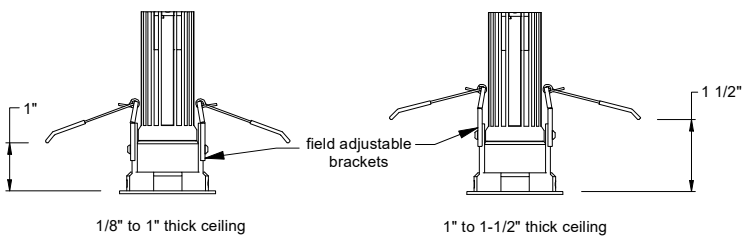



PROJECT INFORMATION		
JOB NAME		TYPE
ORDERING CODE		

## BATTERY OPTIONS

### EMERGENCY BATTERY

IOTA's ILB Battery Backups are UL Listed LED emergency drivers that allow the same LED fixture to be used for both normal and emergency operation. In the event of a power failure, the ILB switches to the emergency mode and operates the existing fixture for 90 minutes. The unit contains a battery, charger, and converter circuit in a single can. The Constant Power design of the ILB maintains the output wattage to the LED array even as the system voltage diminishes. UL 924 Listed for U.S. and Canada. UL 1310 Certified, Output Class 2 Compliant. Includes single-piece TBTS test switch and charge indicator accessory kit. For use with switched and unswitched fixtures, and includes Two-wire universal AC input. Meets or exceeds all National Electric Code and Life Safety Code Emergency Lighting Requirements. Rated for use in Plenum, Damp Location, Recessed Type IC, and Enclosed and Gasketed Luminaires.

### REMOTE TEST SWITCH

The Remote Test Switch may be mounted adjacent to the LED Fixture by others.

### EMERGENCY BATTERY ACCESS

Above ceiling access is recommended for ease of service, but LED Fixture Sizes of 4" and Larger are capable of below ceiling access. IC/ICAT/CP Box and ITS option require an access panel in the ceiling (or other form of access) adjacent to the installation location of the Emergency Battery.

### REMOTE LOCATION

Maximum remote mounting distance of the emergency driver shall be 50 feet. Remote location wiring provided by others. Follow all Local and National Electric/ Building Codes.

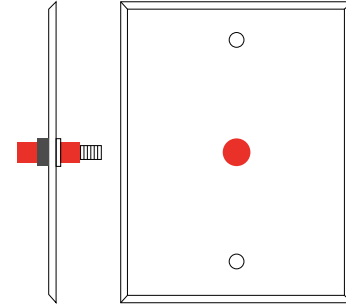

Remote Test Switch

EM MODE OUTPUT (DELIVERED LUMENS)	
LUMEN ORDERING CODE	EM7
ALL OPTIONS ( 05LM TO 07LM)	450
Notes:Based on 30K, 97CRI	

## REMOTE EM BATTERY (REMOTE TEST SWITCH)

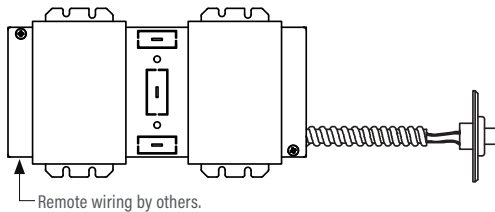

### Accessory

#### 76066 Optional T-Grid Mounting Kit<sup>1</sup>

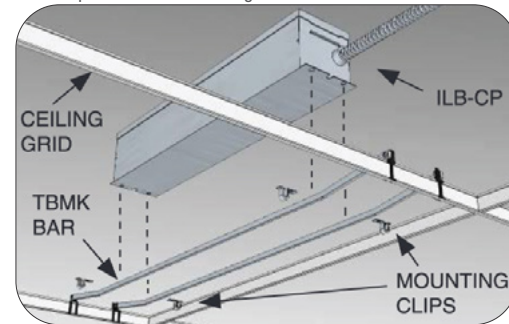

1. Can be used with any of the Emergency Battery Backups. Must be ordered as a separate line item.

PROJECT INFORMATION			
JOB NAME		TYPE	
ORDERING CODE			

## AWNRR OPTIONS

### Athena Wireless Node

The Athena wireless node is a radio frequency (RF) device that enables simple, digital control of individual light fixtures in an Athena control system.



Athena Wireless Node RF

#### AWNRR

Plenum rated and can be installed above the ceiling for wireless control of a fixture without any impact on fixture aesthetics.

#### FEATURES

- Enables individual, wireless control of each fixture in an Athena control system. Accommodates zone and control changes without rewiring.
- Installed at factory – no wiring required on-site. Fixture is ready to communicate wirelessly once power is connected.
- All drivers on the link are controlled as a single zone.

#### REGULATORY APPROVALS

- cULus Listed (UL916)
- Complies with requirements for use in other spaces used for environmental air (plenums) per NEC® 2014 300.22(C)(3).
- FCC compliant with the limits for a Class B digital device.
- IC (Industry Canada)
- ANSI C137.1 0–10 V- Electronic Off

#### POWER / LOAD

- IEC SELV/NEC® Class 2
- 1 Watt

#### ENVIRONMENTAL

- Ambient operating temperature (immediate vicinity of Athena wireless node): **32 °F to 131 °F** (0 °C to 55 °C), 0% to 90% humidity.

#### BATTERY OPTIONS

- For EM options please consult factory.

#### Note: Default behavior prior to programming

- Light level 100%
- Athena wireless node performs an unprogrammed startup sequence on every power up until the device is added to an Athena system.

- Each Athena wireless node should be installed within 25 ft (7.62 m) of two or more Athena wireless nodes or other Clear Connect – Type X devices.
- For Chicago plenum installations, the Athena wireless node may not be installed in the plenum space. It must be installed in the occupied space.

**For servicing the driver/j-box, access above ceiling is required. (NC Mounting)**

**IC/ICAT/CP not available in AWNR.**