

# alphabet

PROJECT INFORMATION		
JOB NAME		TYPE
ORDERING CODE		

## BETA 3

### 3" Cylinder Standard White Wall Wash



WW BEAM		
(Note: Specifications are subject to change without notice)		
10mm COB PERFORMANCE DATA		
LED LIGHT ENGINE	NOMINAL DELIVERED LUMENS	SYSTEM WATTAGE
10LM	840LM @30K/80CRI	9W
15LM	1320LM @30K/80CRI	13W
20LM	1570LM @30K/80CRI	17W
10LM	720LM @30K/90CRI	9W
15LM	1120LM @30K/90CRI	13W
20LM	1340LM @30K/90CRI	17W
Notes	Delivered lumens based on WW optic (see page 2)	



CASAMBI

#### FEATURES

- Seamless extrusion with powder coated finish for clean aesthetics
- Thermally optimized for longevity
- 50° x 30° Wall Wash beam spread
- UGR < 19
- Micro slim canopy options at 1/4"-3/8" depth plus 1/2" diameter stem.
- Multiple mounting, glare control options and finishes available

#### DIMMING AND CONTROLS

- Flicker free 0-10V dimming to 1%
- Leading & trailing edge (Triac/ELV) dimming to 1%
- Lutron Hi-lume 2-Wire (Eco System) dimming to 0.1%
- Casambi bluetooth dimming to 1%

#### CONSTRUCTION

- Extruded aluminum housing
- Lexan™ (PC) Optimal connectivity for wireless control signal
- Machined aluminum canopy
- SVT pendant cord

#### LED

- 90 CRI: SDCM = 2-step MacAdam Ellipse, Lumen Maintenance: L<sub>70</sub> > 66,000 hrs
- 80 CRI: SDCM = 2-step MacAdam Ellipse, Lumen Maintenance: L<sub>70</sub> > 66,000 hrs

#### LISTING

- ULus Listed to UL1598 & UL2108; cUL Listed to CSA C22.2 #250.0
- Suitable for dry and damp locations
- 5 Year Limited warranty

#### ELECTRICAL

- 120V-277V, 120 only Triac / ELV
- Power factor ≥ 0.9
- 2kV driver input surge protection
- Remote emergency test switch
- 7 W, 10W (T20 CEC) and 12W EM 90min battery
- Low Voltage Luminaire option, see page 6.

#### PENDANT

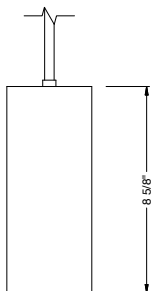

#### SURFACE MOUNT

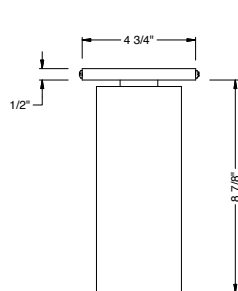

#### WALL MOUNT

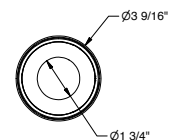
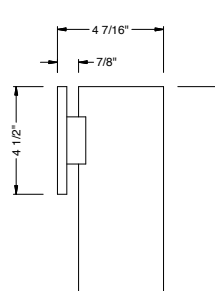

# alphabet

PROJECT INFORMATION		
JOB NAME		TYPE
ORDERING CODE		

ORDERING CODE		
<b>SERIES</b>	<b>BETA</b>	cylinder series
<b>TYPE</b>	<b>3R</b>	3" round
<b>LED</b>	<b>SW</b>	standard white
<b>DELIVERED LUMENS</b>	<b>10LM</b>	840 lm
	<b>15LM</b>	1320 lm
	<b>20LM</b>	1570 lm
Standard Configuration: 3000K 80CRI WW Optic Calculated Delivered Lumens = [Delivered Lumen Value] x [CCT Multiplier] x [Reflector Multiplier]		
<b>CCT</b>	<b>27K</b>	2700K
	<b>30K</b>	3000K
	<b>35K</b>	3500K
	<b>40K</b>	4000K
CCT MULTIPLIER FOR LUMEN OUTPUT		
<b>CRI</b>	<b>80</b>	80 CRI
	<b>90</b>	90 CRI
<b>OPTIC &amp; LM MULTIPLIER</b> SEE PAGE 3	<b>WW</b>	wall wash with diffused angle bending lens
<b>FINISH</b> SEE PAGE 3	<b>BK</b>	black
	<b>WH</b>	white
	<b>MC</b>	matte chrome
	<b>CC<sup>1</sup></b>	custom color, consult factory for details
Antimicrobial finish, add <b>AM</b> to black, white or matte chrome i.e. BKAM.		
<b>BEZEL COLOR</b> SEE PAGE 3	<b>BK</b>	black (0.98)
	<b>WH</b>	white (1.00)
	<b>MC</b>	matte chrome (0.99)
	<b>BZ</b>	bronze (0.98)
	<b>WT</b>	wheat (0.99)
	<b>CC<sup>1</sup></b>	custom color, consult factory for details
Antimicrobial finish, add <b>AM</b> to black, white or matte chrome i.e. BKAM.		

ORDERING CODE		
<b>MOUNTING OPTIONS</b> SEE PAGE 5	<b>W</b>	wall mount
	<b>S</b>	surface mount
	<b>JCOV-S</b>	conduit junction box cover with knockouts, surface
	<b>P</b>	pendant, 108" flexible cord
	<b>RP</b>	rigid pendant 4' stem with swivel stem/canopy
	<b>RP5</b>	rigid pendant 5' stem with swivel stem/canopy
	<b>RP6</b>	rigid pendant 6' stem with swivel stem/canopy
	<b>RP8</b>	rigid pendant 8' stem with swivel stem/canopy
	<b>RP10</b>	rigid pendant 10' stem with swivel stem/canopy
	<b>RPF2</b>	rigid pendant 2' with fixed stem/canopy, not field cuttable
	<b>RPF3</b>	rigid pendant 3' with fixed stem/canopy, not field cuttable
<b>RPF4</b>	rigid pendant 4' with fixed stem/canopy, not field cuttable	
<b>RPF6</b>	rigid pendant 6' with fixed stem/canopy, not field cuttable	
<b>JCOV-XX<sup>2</sup></b>	conduit junction box cover with knockouts, complete XX code with desired pendant mount	
<b>VOLTAGE</b>	<b>120</b>	120V
	<b>UNV</b>	120V-277V
	<b>LVL<sup>3</sup></b>	low voltage luminaire
<b>DIMMING</b>	<b>DIM10</b>	0-10V dimming to 1%
	<b>LUTP</b>	Lutron Hi-lume Premier Ecosystem dimming to 0.1%, Soft-on & Fade-to-Black
	<b>ELV1<sup>4</sup></b>	leading & trailing edge (Triac/ELV) dimming to 1%
	<b>CAS</b>	Casambi Bluetooth control with flicker free 1% dimming
	<b>ND</b>	No Driver Included. Customer to Supply PoE system components or order remote driver separately. Refer to POE/Remote Driver reference sheet for additional details.
<b>ELECTRICAL OPTIONS</b>	<b>EM7</b>	remote emergency battery backup, 90 minutes at 7 watts to LED
	<b>EM12</b>	remote emergency battery backup, 90 minutes at 12 watts to LED
	<b>EM10CA20</b>	remote emergency battery backup, 90 minutes at 10W to LED, CA title 20

YOUR COMPLETED ORDERING CODE	
Follow the steps to specify your fixture, example:	
<b>BETA - 3R - SW - 15LM - 35K - 80 - WW - WH - WH - P - UNV - DIM10 - EM7</b>	

## NOTES

1. Custom set up fee plus minimum quantity required per color.
2. JCOV not available with RP mounting.
3. Must select ND dimming code, for remote driver or POE specifications see page 5.
4. ELV1 available in 120V.

\*Slim canopy with rigid stem connection shall be used in jurisdictions that DO NOT require light fixtures to freely swing in lateral directions, complying with local and national building codes.

\*RP mounting with swivel is recommended to be installed on a 4in square or 4in deep regress 2-1/8" octagonal junction box.

## BEZEL OPTIONS

### BEZEL COLORS



PROJECT INFORMATION		
JOB NAME		TYPE
ORDERING CODE		

## PHOTOMETRIC DATA DIAGRAM

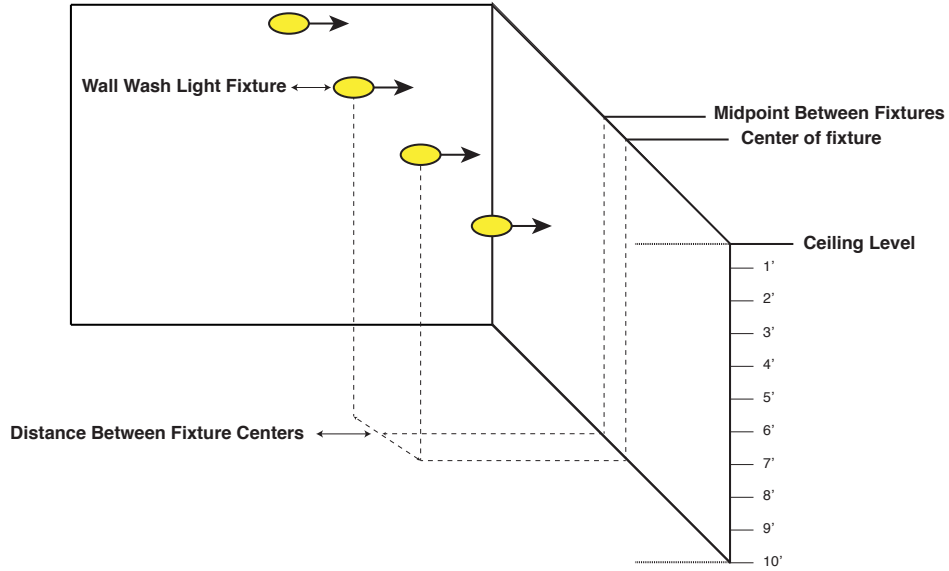

## PHOTOMETRIC DATA CHARTS

### FOOT CANDLE MEASUREMENT

#### STANDARD WHITE WALL WASH 20LM 80CRI 3000K

MOUNTING DISTANCE	2' FROM WALL						3' FROM WALL						4' FROM WALL					
	2' ON CENTER		3' ON CENTER		4' ON CENTER		2' ON CENTER		3' ON CENTER		4' ON CENTER		3' ON CENTER		4' ON CENTER		6' ON CENTER	
DISTANCE FROM CEILING	CENTER	MID POINT	CENTER	MID POINT	CENTER	MID POINT	CENTER	MID POINT	CENTER	MID POINT	CENTER	MID POINT	CENTER	MID POINT	CENTER	MID POINT	CENTER	MID POINT
1'	16.9	13.2	15.5	5.6	14.3	3.1	3.4	3.6	2.7	2.4	2.2	1.7	2.1	3	1.3	2.3	0.7	1.5
2'	77.2	72.6	69.7	28.2	68.2	9.7	17.6	16.8	13.8	10.5	12.8	5.8	4.9	4.9	4.2	3.3	3.9	1.4
3'	78.5	78.2	56.8	48.6	52.9	26.7	48.1	49.6	34.3	32.2	31.5	17.8	12.7	11.3	10.9	7.5	10	3.1
4'	59.2	59.3	41	39.3	34.8	26.3	53.1	53.9	36.6	36.7	29	26.3	24	25.3	19.3	18.1	17.4	7
5'	41.4	41.9	29	28.7	23.2	20.9	45.4	46.6	32.2	32.2	24.9	23.9	27.3	27.4	20.6	20.9	16.3	11.7
6'	28.8	29.5	20.8	20.7	16.1	15.7	35.8	37.1	26.3	26.3	20.2	19.9	25.4	25.9	19.6	19.6	14.2	12.1
7'	20.4	20.9	15.1	15.2	11.7	11.7	27.6	28.6	20.8	21	16.1	16	22.1	22.6	17.3	17.3	12.2	11.2
8'	14.7	15.1	11.2	11.4	8.8	8.9	21.1	21.8	16.3	16.6	12.8	12.8	18.5	19.1	14.8	14.8	10.2	9.8
9'	10.9	11.2	8.5	8.7	6.8	6.8	16.2	16.7	12.8	13.1	10.2	10.3	15.3	15.9	12.4	12.5	8.6	8.4
10'	8.2	8.4	6.5	6.7	5.3	5.4	12.6	12.9	10.2	10.4	8.2	8.3	12.6	13.1	10.4	10.5	7.2	7.2

PROJECT INFORMATION		
JOB NAME		TYPE
ORDERING CODE		

## PHOTOMETRIC DATA CHARTS

### FOOT CANDLE MEASUREMENT

STANDARD WHITE WALL WASH 15LM 80CRI 3000K																		
MOUNTING DISTANCE	2' FROM WALL						3' FROM WALL						4' FROM WALL					
FIXTURE SPACING	2' ON CENTER		3' ON CENTER		4' ON CENTER		2' ON CENTER		3' ON CENTER		4' ON CENTER		3' ON CENTER		4' ON CENTER		6' ON CENTER	
DISTANCE FROM CEILING	CENTER	MID POINT	CENTER	MID POINT	CENTER	MID POINT	CENTER	MID POINT	CENTER	MID POINT	CENTER	MID POINT	CENTER	MID POINT	CENTER	MID POINT	CENTER	MID POINT
1'	14.2	11	13	4.7	12	2.6	2.8	3	2.3	2	1.8	1.4	1.8	2.5	1.1	2	0.6	1.3
2'	64.6	60.7	58.3	23.6	57.1	8.1	14.7	14.1	11.5	8.8	10.7	4.9	4.1	4.1	3.5	2.8	3.2	1.2
3'	65.7	65.5	47.5	40.7	44.3	22.3	40.2	41.5	28.7	27	26.4	14.9	10.6	9.5	9.1	6.3	8.3	2.6
4'	49.6	49.6	34.3	32.9	29.2	22	44.5	45.1	30.6	30.7	24.3	22	20.1	21.2	16.2	15.2	14.6	5.9
5'	34.7	35.1	24.3	24.1	19.4	17.5	38	39	27	27	20.9	20	22.9	23	17.2	17.5	13.6	9.8
6'	24.1	24.7	17.4	17.4	13.5	13.1	30	31	22	22	16.9	16.7	21.3	21.7	16.4	16.4	11.9	10.2
7'	17.1	17.5	12.6	12.7	9.8	9.8	23.1	23.9	17.4	17.5	13.5	13.4	18.5	19	14.5	14.5	10.2	9.4
8'	12.3	12.7	9.4	9.5	7.4	7.4	17.6	18.2	13.6	13.9	10.7	10.7	15.5	16	12.4	12.4	8.6	8.2
9'	9.1	9.4	7.1	7.3	5.7	5.7	13.6	14	10.7	11	8.6	8.6	12.8	13.3	10.4	10.5	7.2	7.1
10'	6.9	7	5.5	5.6	4.4	4.5	10.5	10.8	8.5	8.7	6.9	7	10.6	11	8.7	8.8	6.1	6

STANDARD WHITE WALL WASH 10LM 80CRI 3000K																		
MOUNTING DISTANCE	2' FROM WALL						3' FROM WALL						4' FROM WALL					
FIXTURE SPACING	2' ON CENTER		3' ON CENTER		4' ON CENTER		2' ON CENTER		3' ON CENTER		4' ON CENTER		3' ON CENTER		4' ON CENTER		6' ON CENTER	
DISTANCE FROM CEILING	CENTER	MID POINT	CENTER	MID POINT	CENTER	MID POINT	CENTER	MID POINT	CENTER	MID POINT	CENTER	MID POINT	CENTER	MID POINT	CENTER	MID POINT	CENTER	MID POINT
1'	9.1	7	8.3	3	7.7	1.6	1.8	1.9	1.5	1.3	1.2	0.9	1.1	1.6	0.7	1.3	0.4	0.8
2'	41.3	38.8	37.3	15.1	36.5	5.2	9.4	9	7.4	5.6	6.8	3.1	2.6	2.6	2.3	1.8	2.1	0.7
3'	42	41.8	30.4	26	28.3	14.3	25.7	26.5	18.4	17.3	16.9	9.5	6.8	6.1	5.8	4	5.3	1.7
4'	31.7	31.7	21.9	21	18.6	14.1	28.4	28.9	19.6	19.6	15.5	14	12.8	13.6	10.3	9.7	9.3	3.8
5'	22.2	22.4	15.5	15.4	12.4	11.2	24.3	24.9	17.3	17.2	13.3	12.8	14.6	14.7	11	11.2	8.7	6.3
6'	15.4	15.8	11.1	11.1	8.6	8.4	19.2	19.8	14.1	14.1	10.8	10.7	13.6	13.9	10.5	10.5	7.6	6.5
7'	10.9	11.2	8.1	8.1	6.3	6.3	14.7	15.3	11.1	11.2	8.6	8.6	11.8	12.1	9.3	9.3	6.5	6
8'	7.9	8.1	6	6.1	4.7	4.7	11.3	11.7	8.7	8.9	6.9	6.9	9.9	10.2	7.9	7.9	5.5	5.3
9'	5.8	6	4.5	4.6	3.6	3.7	8.7	8.9	6.9	7	5.5	5.5	8.2	8.5	6.7	6.7	4.6	4.5
10'	4.4	4.5	3.5	3.6	2.8	2.9	6.7	6.9	5.4	5.6	4.4	4.5	6.8	7	5.5	5.6	3.9	3.8

**NOTE**

1. Performance based on typical reflectance values and room dimensions. IES files available at [ledrabrands.com](http://ledrabrands.com)

# alphabet

PROJECT INFORMATION		
JOB NAME		TYPE
ORDERING CODE		

## MOUNTING OPTIONS

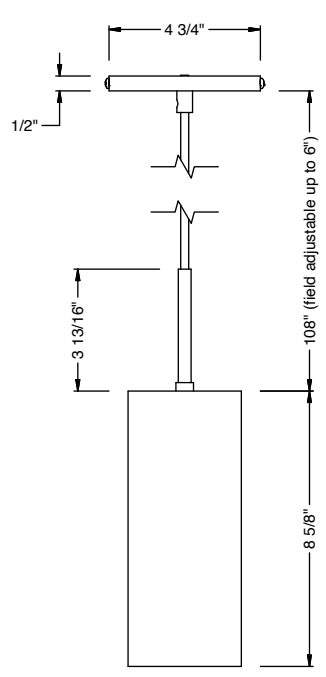

**PENDANT**  
ELV1 / CAS / ND

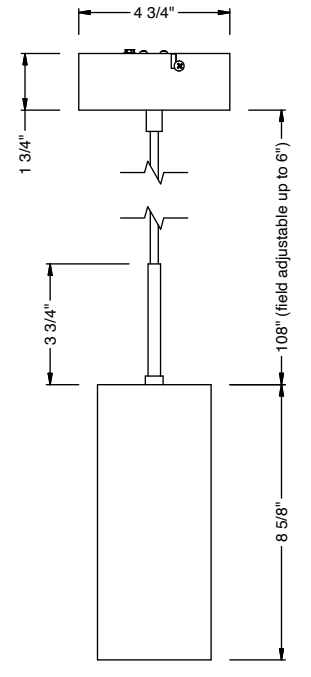

**PENDANT**  
DIM10 / LUTP

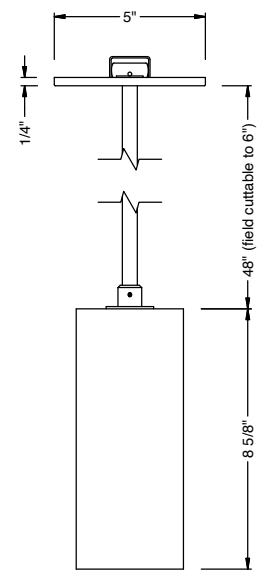

**RP SWIVEL**  
DIM10 / ELV1 / CAS / LUTP / ND

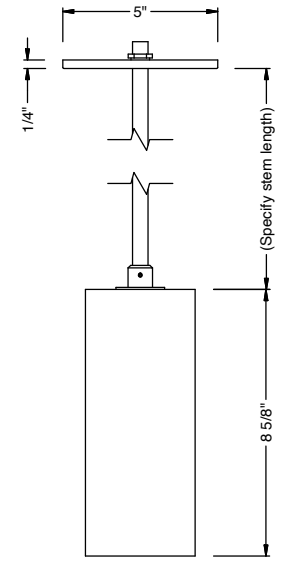

**RPF FIXED**  
DIM10 / ELV1 / CAS / LUTP / ND

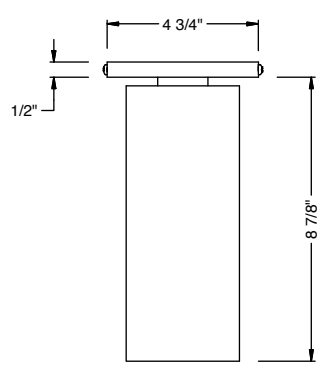
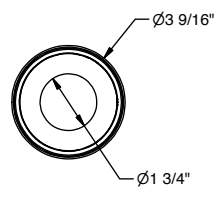

**SURFACE MOUNT**  
DIM10 / ELV1 / CAS / LUTP / ND

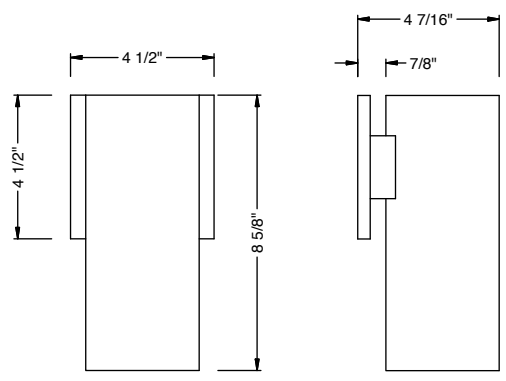

**WALL MOUNT**  
DIM10 / ELV1 / CAS / LUTP / ND

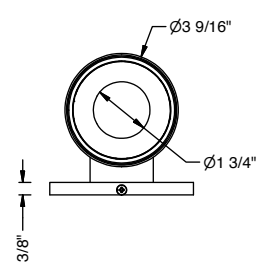

PROJECT INFORMATION		
JOB NAME		TYPE
ORDERING CODE		

## LOW VOLTAGE OPTIONS

### WW BEAM

#### 10mm COB PERFORMANCE DATA

LED LIGHT ENGINE	NOMINAL DELIVERED LUMENS	DRIVE CURRENT	LED WATTAGE
10LM	840LM @30K/80CRI	250mA	9W
15LM	1320LM @30K/80CRI	325mA	12W
20LM	1570LM @30K/80CRI	400mA	14.5W
10LM	720LM @30K/90CRI	200mA	7W
15LM	1120LM @30K/90CRI	325mA	12W
20LM	1340LM @30K/90CRI	400mA	14.5W
Notes	Delivered lumens based on WW optic no lens, (see page 2)		

## NOMINAL LED VOLTAGE: 36VDC

Customer to order CC Remote Driver separately or POE Node by others.

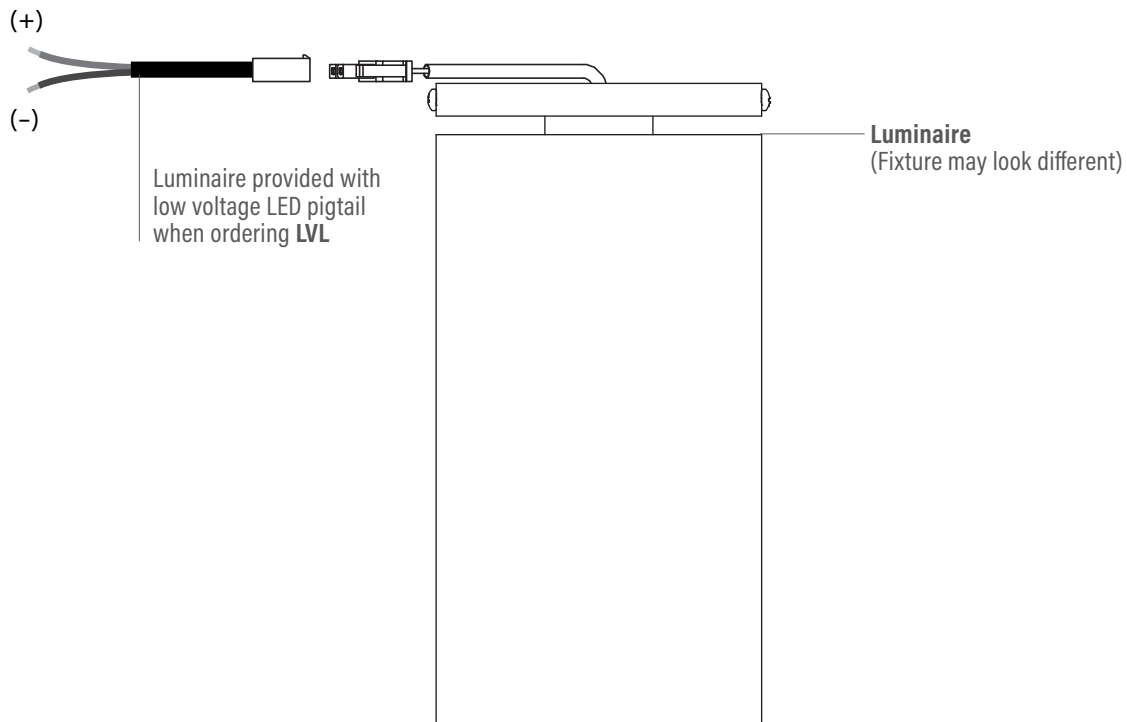

PROJECT INFORMATION		
JOB NAME		TYPE
ORDERING CODE		

## BATTERY OPTIONS

### EMERGENCY BATTERY

IOTA's ILB battery backups are UL Listed LED emergency drivers that allow the same LED fixture to be used for both normal and emergency operation. In the event of a power failure, the ILB switches to the emergency mode and operates the existing fixture for 90 minutes. The unit contains a battery, charger, and converter circuit in a single can. The constant power design of the ILB maintains the output wattage to the LED array even as the system voltage diminishes. UL 924 Listed for U.S. and Canada. UL 1310 Certified, output class 2 compliant. Includes single-piece TBTS test switch and charge indicator accessory kit. For use with switched and unswitched fixtures, and includes two-wire universal AC input. Meets or exceeds all National Electric Code and Life Safety Code Emergency Lighting requirements. Rated for use in plenum, damp location, recessed type IC, and enclosed and gasketed luminaires.

### REMOTE TEST SWITCH

The remote test switch can be mounted adjacent to the LED Fixture by others.

### EMERGENCY BATTERY ACCESS

Above ceiling access is recommended for ease of service.

### REMOTE LOCATION

Maximum remote mounting distance of the emergency driver shall be 50 feet. Remote location wiring provided by others. Follow all local and national electric/building codes.

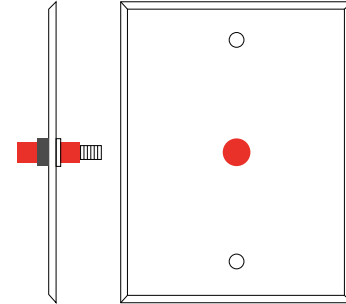

Remote Test Switch

EM MODE OUTPUT (DELIVERED LUMENS)			
LUMEN ORDERING CODE	EM7	EM10	EM12
ALL OPTIONS (10LM TO 20LM)	880LM	1280LM	1480LM
Notes: Based on 30K, 80CRI			

## REMOTE BATTERY

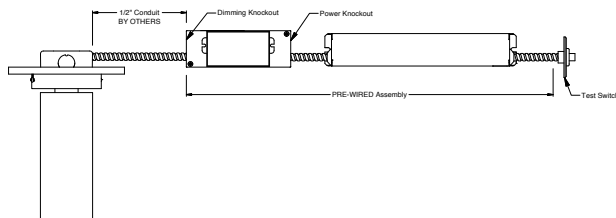
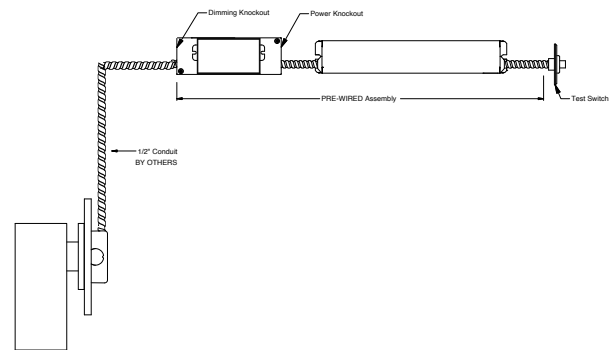
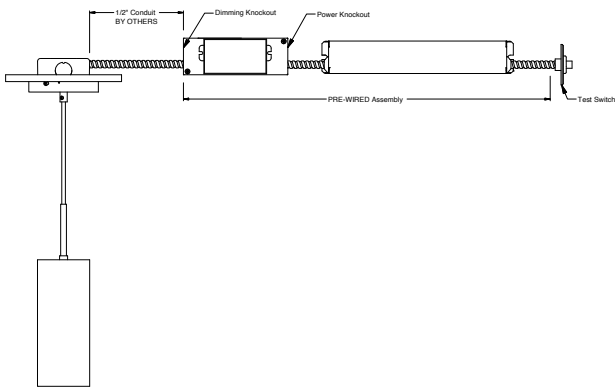

### Accessory

76066 Optional T-Grid Mounting Kit<sup>1</sup>

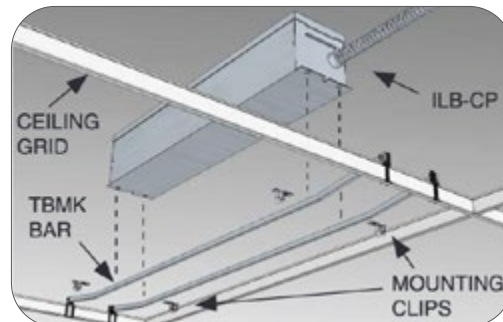

1. Can be used with any of the Emergency Battery Backups. Must be ordered as a separate line item.